

IDOS UPM

**Intelligent Digital Output Sensor
Universal Pressure Module**
Instruction Manual

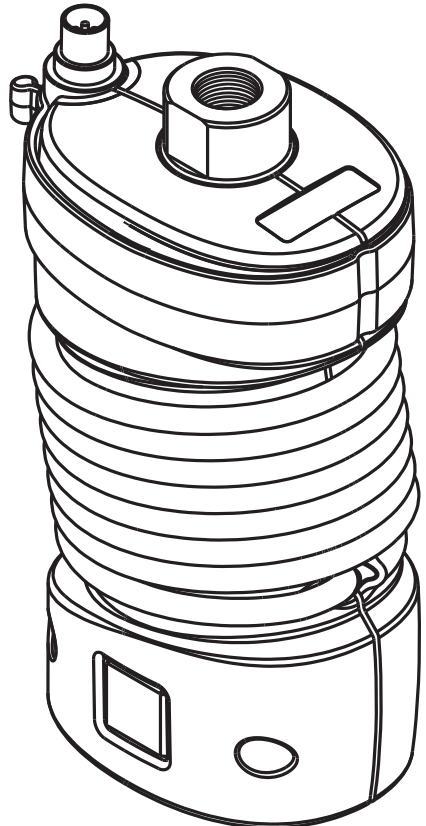

A1

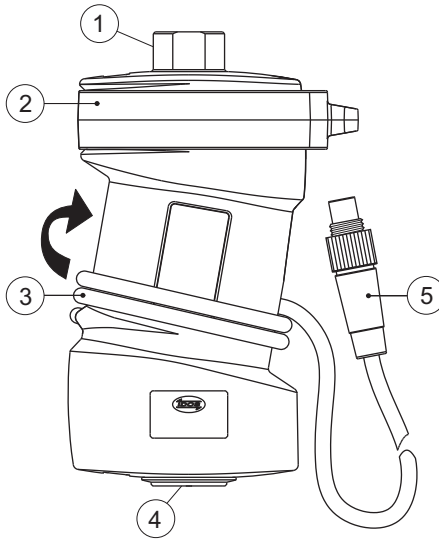

B1

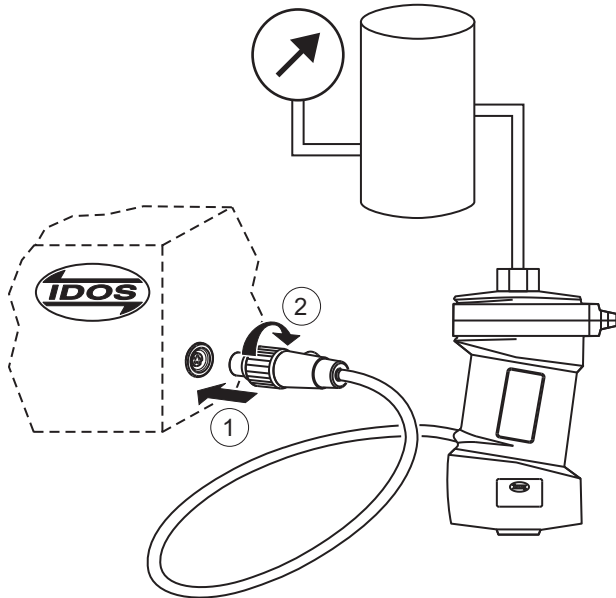

C1

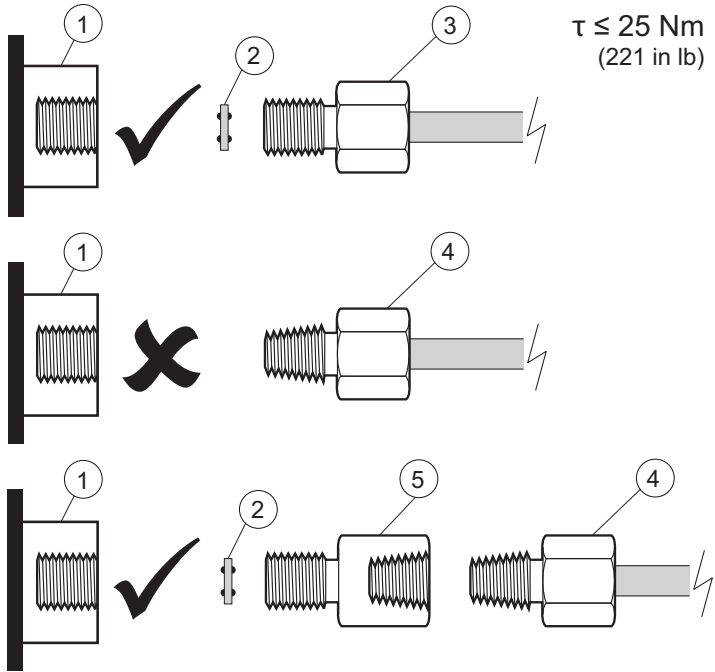

C2

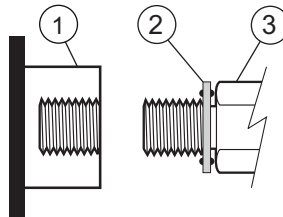

C3

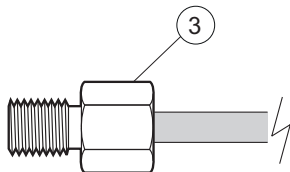
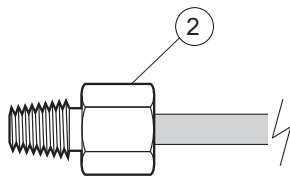
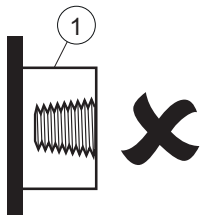
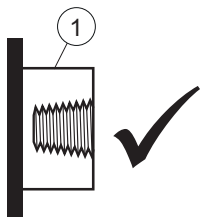

$\tau \leq 35 \text{ Nm}$
(310 in lb)

C4

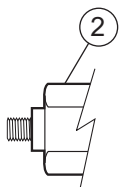
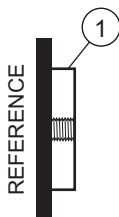

$\tau \leq 2 \text{ Nm}$
(18 in lb)

Introduction

The IDOS Universal Pressure Modules (UPM) use Intelligent Digital Output Sensor (IDOS) technology to measure the applied pressure and supply the data to an IDOS instrument.

The IDOS technology gives instant plug and play functionality with all instruments that have the IDOS facility. The power for the UPM comes from the IDOS instrument.

For the full specification and user manual, refer to Druck website:



<https://druck.com/essential>



WARNING Do not use with media that has an oxygen concentration > 21 % or other strong oxidizing agents.

This product contains materials or fluids that may degrade or combust in the presence of strong oxidizing agents.

Some liquid and gas mixtures are dangerous. This includes mixtures that occur because of contamination. Make sure that the UPM is safe to use with the necessary media.

It is dangerous to ignore the specified limits (refer to data sheet) for the UPM or to use the UPM when it is not in its normal condition. Use the applicable protection and obey all safety precautions.

To prevent a dangerous release of pressure, isolate and bleed the system before disconnecting a pressure connection. A dangerous release of pressure can cause injury.

Do not apply pressure greater than the maximum safe working pressure.

Do not apply pressure greater than that specified in Table 5 to the REFERENCE pressure port.

Safety





The UPM has been designed to be safe when operated using the procedures detailed in this manual. Do not use this equipment for any other purpose than that stated, the protection provided by the equipment may be impaired.

Before installing and using the UPM, read and understand all the related data. This includes: all local safety procedures and installation standards, and this document.

Repair

Do not do repairs to this equipment. Return the equipment to the manufacturer or an approved service agent.

Symbols

Symbol	Description
	This equipment meets the requirements of all relevant European safety directives. The equipment carries the CE mark.
	This equipment meets the requirements of all relevant UK Statutory Instruments. The equipment carries the UKCA mark.
	This symbol, on the equipment, indicates a warning and that the user should refer to the user manual.
	Druck is an active participant in the UK and EU Waste Electrical and Electronic Equipment (WEEE) take-back initiative (UK SI 2013/3113, EU directive 2012/19/EU). The equipment that you bought has required the extraction and use of natural resources for its production. It may contain hazardous substances that could impact health and the environment. In order to avoid the dissemination of those substances in our environment and to diminish the pressure on the natural resources, we encourage you to use the appropriate take-back systems. Those systems will reuse or recycle most of the materials of your end life equipment in a sound way. The crossed-out wheeled bin symbol invites you to use those systems. If you need more information on the collection, reuse, and recycling systems, please contact your local or regional waste administration. Please visit the link below for take-back instructions and more information about this initiative.
	https://druck.com/weee

Installation



WARNING Only fluids that are compatible with Stainless Steel and Hastelloy shall be used with the pressure sensors. This is to ensure the integrity of the pressure sensor and avoid fluid leakage.



CAUTION To prevent damage, do not apply torque to the body of the UPM. If available, use the flat faces on the pressure connector to hold the UPM in position.

For an overview of the equipment connections, refer to Figure A1 and the explanation below:

1. Pressure port.
2. Cable strap.
3. UPM cable. For storage, wind the cable in the direction shown.
4. Reference pressure port on a gage (g) and differential (d) sensor. PTFE vent on sealed gage (sg) or absolute (a) sensor. Refer to Table 3.

- Communications port connector for an IDOS instrument. The connector includes a thread to lock the connector in position.

Pressure Connection

Before starting, refer to the MWP (maximum working pressure) rating specified on the product label.

Pressure port connections for G1/8 fittings are shown in Figure C1.

- UPM G1/8 pressure connector.
- Bonded Seal, e.g. Dowty 400-003-4490-41 or equivalent.
- ISO 228/1 G1/8 pressure connector.
- NPT pressure connector.
- NPT female to G1/8 male adapter **IO-ADAPT-1/4NPT** or **IO-ADAPT-1/8NPT**.

For pressures less than 100 bar (1450 psi) when using G1/8 fittings, see alternative sealing method in Figure C2 and the key below:

- UPM G1/8 pressure connector.
- Bonded seal.
- ISO228/1 G1/8 pressure connector or adaptor.

Pressure port connections for NPT fittings are shown in Figure C3.

- UPM 1/8 NPT pressure connector.
- NPT pressure connector.
- ISO 228/1 G1/8 pressure connector.

Pressure port connection to the UPM reference port is shown in Figure C4.

- UPM 1/8 reference port pressure connector. M5 or 10-32 UNF, refer to Table 3.
- Pressure connector.

Electrical Connection

The equipment has a single electrical cable, item 5 in Figure A1. This is for connecting to a Druck DPI8XX series, DPI620G or PACE.

Pressure Safety

This equipment meets the requirements of the European Pressure Equipment Directive 2014/68/EU for pressure safety.

Maintenance

Clean the case with a moist, lint-free cloth and a weak detergent. Do not use solvents or abrasive materials.

Return Goods/Material Procedure

If the unit requires calibration or is unserviceable, return it to the nearest Druck Service Centre listed at:

<https://druck.com/service>.

Contact the Service Department to obtain a Return Goods/Material Authorization (RGA or RMA). Provide the following information for a RGA or RMA:

- Product (e.g. UPM)
- Serial number.
- Details of defect/work to be undertaken.
- Calibration traceability requirements.
- Operating conditions.

Operation

Connect the UPM pressure sensor to the IDOS port of the IDOS compatible test instrument.

The power can be on or off when you attach the UPM cable to the test instrument.

To measure the pressure, refer to the user manual of IDOS compatible instrument.

Calibration

Note: Druck can provide a calibration service that is traceable to international standards.

We recommend that you return the UPM to the manufacturer or an approved service agent for calibration. If you use an alternative calibration facility, make sure that it uses these standards.

Equipment and Conditions

To do an accurate calibration, you must have:

- An IDOS compatible instrument, for example: Druck DPI8XX series, DPI620G or PACE.
- An suitable pressure standard (primary or secondary) with a total uncertainty of 0.01% reading or better.
- A stable temperature environment: $21 \pm 1^\circ\text{C}$ ($70 \pm 2^\circ\text{F}$).

Procedure

- Connect the UPM to the IDOS instrument and to the pressure standard, see Figure B1.
- Allow the equipment to achieve a stable temperature. Leave powered on for a minimum of 30 minutes.
- Use the calibration menu on the IDOS instrument to do a two-point calibration (Zero and +FS) or a three-point calibration (-FS, Zero and +FS). Refer to Table 1.

Table 1: Calibration Pressures

Type	Pressure	Nominal Applied Pressure psi (mbar)		
		-FS ^a	Zero	+FS
g/d	≤ 10.0 psi (700 mbar)	-FS	0	+FS
g/d	> 10.0 psi (700 mbar)	-13.1 (-900)	0	+FS
a	5.00 psi (350 mbar)	n/a	< 0.02 (1.0)	+FS
a	30.0 psi (2 bar)	n/a	< 0.07 (5.0)	+FS
a	100.0 psi (7 bar)	n/a	< 0.29 (20.0)	+FS
a	300.0 psi (20 bar)	n/a	< 0.73 (50.0)	+FS
sg	≥ 5000 psi (350 bar)	n/a	0 ^b	+FS

a. For a three-point calibration, do not apply more than -90% of the specified FS for the unit.

b. For sg sensors, use atmospheric pressure as zero.

- The display shows the applicable instructions to complete the calibration.
- To make sure that the calibration is correct, apply these pressures to the UPM and record the results:
 - Ranges g/d or sg: 0, 20, 40, 60, 80, 100 (%FS)
 - Then: Go back to 0 in the same steps.
 - Then (three-point calibration only): -20, -40, -60, -80, -100 (%FS)
 - Then: Go back to 0 in the same steps.
 - Ranges a: 0, 20, 40, 60, 80, 100 (%FS)
 - Then: Go back to 0 in the same steps.

Standard Accuracy

The specified accuracy (refer to Specification data) includes an allowance for temperature changes, reading stability for one year, and the uncertainty of the standard used for calibration.

In step 5, make sure that the error between the applied pressure and the reading on the unit is not more than 0.015% FS.

Premier Precision

The specified precision (refer to Specification data) includes an allowance for temperature changes and the uncertainty of the standard used for calibration. In step 5, make sure that the error between the applied pressure and the reading on the unit is not more than the specified value for Premier precision.

Specification

Pressure Measurement

All accuracy statements are for one year. The % full scale (FS) statements for Standard accuracy and Premier precision are only applicable if there is a regular zero correction by the IDOS instrument.

Table 2: Pressure Measurement Specification

Ranges: Gage and differential operation (g/d), sealed gage (sg), absolute (a)	Type	Standard Accuracy ^a %FS	Premier Precision ^b %FS	Notes
± psi: 0.36 (± mbar: 25)	g/d	0.1	0.03	1/2
± psi: 1, 3, 5, 10 (± mbar: 70, 200, 350, 700)	g/d	0.075	0.03	1/2
psi: -15 to [15 or 30] (bar: -1 to [1 or 2])	g/d	0.05	0.01	1/2
psi: -15 to [50, 100, 150, or 300] (bar: -1 to [3.5, 7, 10, or 20])	g/d	0.05	0.01	1/3
psi: 500, 1000, 1500, 2000, 3000 (bar: 35, 70, 100, 135, 200)	g/d	0.05	0.01	1/3
psi: 5 (mbar: 350)	a	0.1	–	2
psi: 30 (bar: 2)	a	0.075	–	2
psi: 100, 300 (bar: 7, 20)	a	0.075	–	3
psi: 5000, 10000 (bar: 350, 700)	sg	0.05	–	3

a. Standard accuracy is for 32 to 122°F (0 to 50°C); Stability: 1 year

b. Premier precision is for 65 to 82°F (18 to 28°C);
Stability: ≤ 10 psi (700 mbar) = 0.02% of reading/Year
Stability: > 10 psi (700 mbar) = 0.01% of reading/Year
Premier precision for 41 to 113°F (5 to 45°C):
≤ 10 psi (700 mbar): 0.075% FS
> 10 psi (700 mbar): 0.014% FS

Notes:

- Reference port media: Non-corrosive, dry gas.
- + port media: Non-corrosive, non-conductive liquid or Non-corrosive, dry gas.
- + port media: Media applicable to stainless steel.

Table 3: UPM Pressure Connections

Ranges	Pressure Connections
g/d: ≤ 30 psi g (2 bar g)	1/8 NPT female (+ port) + 1/8 NPT female reference port OR G1/8 female (+ port) + G1/8 female reference port
g/d: > 30 psi g (2 bar g)	1/8 NPT female (+ port) + 10-32 UNF reference port OR G1/8 female (+ port) + M5 reference port
sg or a: all ranges	G1/8 female (+ port) OR 1/8 NPT female (+ port)

Table 4: Maximum Pressure (+ port)

Ranges: g/d, sg, a	MWP	Maximum Transient / Intermittent Pressure
≤ 5 psi (350 mbar)	2 x FS	4 x FS
> 5 psi (350 mbar)	1.2 x FS	2 x FS

Table 5: Maximum Pressure (Reference Port)

Ranges: g/d only	MWP
≤ 5 psi (350 mbar)	2 x FS
10 to 15 psi (700 mbar to 1 bar)	1.2 x FS
≥ 30 psi (2 bar)	30 psi (2 bar)

General

Table 6: General Specification

Parameter	Value
Operating temperature	14 to 122°F (-10 to 50°C)
Storage temperature	-4 to 158°F (-20 to 70°C)
Humidity	0 to 90% without condensation (Def Stan 66-31, 8.6 cat III)
Shock/Vibration	EN 61010:2010; Def Stan 66-31, 8.18 and 8.4 cat III
EMC	EN 61326-1:2013
Safety	Electrical - EN 61010-1:2010; Pressure Equipment Directive - Class: Sound Engineering Practice (SEP); CE and UKCA Marked
Size (L:W:H)	Maximum: 5.1 x 2.4 x 1.8 in (130 x 60 x 45 mm)
Weight	8.5 to 11.5 oz (240 to 325 g)

Office Locations



<https://druck.com/contact>

Services and Support Locations



<https://druck.com/service>