



# RPS/DPS8000H

## Hydrogen Focused High Accuracy Resonant Pressure Sensor

Since 1972, Druck has manufactured precision pressure sensors with a capability to meet critical applications in industrial, aerospace, oil and gas, and research environments. Today, Druck is part of Baker Hughes and has continually worked to develop and improve on the performance of our pressure sensors to meet our customers' requirements.

The RPS/DPS8000H combines ground-breaking TERPS technology and a hydrogen barrier coating to create the most accurate and stable hydrogen-capable pressure sensor on the market today. TERPS is a resonant silicon pressure sensor technology platform that provides an order of magnitude greater accuracy and stability than current pressure measurement technologies. TERPS technology also extends the pressure range capability to high pressures and, by incorporating true pressure media isolation, greatly improves its suitability for use in harsh environments.

### Challenges in hydrogen pressure measurement

As a market leader in pressure measurement for the past 50 years, Druck is fully aware of the challenges that hydrogen applications pose for pressure sensors due to the unique behaviour of the medium. Exposure to hydrogen gas can impact the performance of a pressure sensor, specifically via the processes of hydrogen permeation and embrittlement, hence key design aspects need to be considered with a hydrogen pressure sensor to maintain accuracy and stability.

In addition to providing the performance and packaging improvements available with TERPS, the RPS/DPS8000 product line takes advantage of best practices to offer a wide range of pressure and electrical connections to enable a level of customization for your specific requirements never before available in the performance class of this sensor.

The combination of the power of the TERPS technology and the quality, reliability and flexibility of the RPS/DPS8000H Series offers a truly unique solution for high accuracy and high stability pressure measurement in a hydrogen-rich media.

### Features

- High Precision,  $\pm 0.01\%$  FS over compensated temperature range
- High Stability,  $\pm 100$  ppm FS/year
- Wide temperature range, up to  $-55^{\circ}\text{C}$  to  $+125^{\circ}\text{C}$  ( $-40^{\circ}$  to  $257^{\circ}\text{F}$ )
- Media isolated construction, suitable for use in harsh environments
- Suitable for use in hydrogen rich media
- Multiple Output configurations, RS-232, RS-485, USB 2.0, CANbus, Frequency & Diode (TTL)
- Wide selection of pressure & electrical connections to suit specific requirements

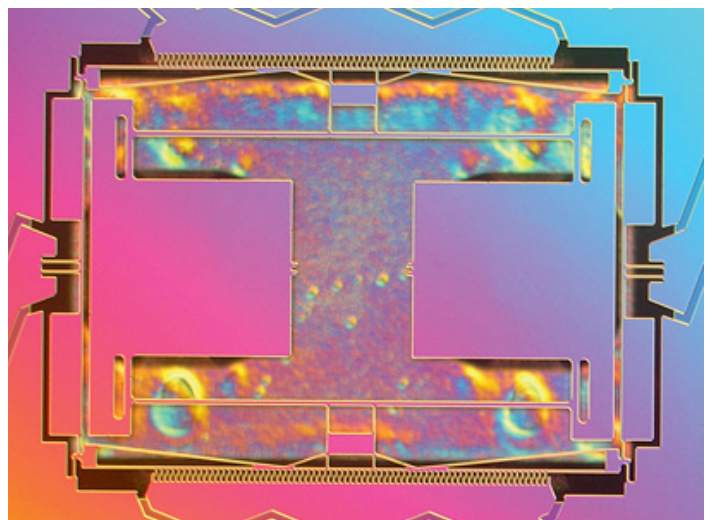

# Specifications

## Measurement

### Base Pressure Ranges

- 0 to 7 bar (0 to 101 psi) absolute
- 0 to 14 bar (0 to 203 psi) absolute
- 0 to 20 bar (0 to 290 psi) absolute
- 0 to 35 bar (0 to 507 psi) absolute
- 0 to 70 bar (0 to 1015 psi) absolute
- 0 to 104 bar (0 to 1508 psi) absolute

### Calibrated Ranges

Any zero-based range between 2 and 104 bar (29 to 1508 psi) can be specified. (Performance will be of the full scale of the base pressure range selected.)

The lowest calibrated pressure is 35 mbar absolute. Other pressure ranges are available on request, please contact Druck for more details.

### Overpressure

1.5X FS

### Sensor Failure Pressure

2.0X FS

### Pressure Containment

- 70 bar (1015 psi) for ranges to 7 bar (101 psi)
- 200 bar (2900 psi) for ranges to 104 bar (1508 psi)

### Supply and Output

Electronics Option	Supply Voltage (V DC)	Output	Current Consumption <sup>(2)</sup> (mA)
1	5 to 32	Frequency & Diode TTL <sup>(1,3,4)</sup>	3.5
F	5 to 32	RS485	<14 quiescent, 32 max
G	5 to 32	RS232	<14 quiescent, 32 max
C	9 to 28	CANbus	16.5 quiescent, 32 max
V	4.8 to 5.2	USB 2.0	20 quiescent

1. Jitter less than 20 ns

2. Full temperature range

3. Square wave pressure signal, 25 kHz nominal, 4–10 kHz span

4. Forward voltage diode, 0.5 to 0.7 V @ 25°C (77°F), typically -2 mV/°C nominal

### Response Time

< 300 msec for pressure change from 10% to 90% FS

### Supply Response

TTL/RS232/RS485/USB: Accurate to specification within 500 ms of power up, over all operating temperatures

CANbus: Accurate to specification within 10 min of power-up

### Electrical Protection

RS232/485/CANbus/TTL: Connecting Vsupply and GND between any combinations of pins on the connector will not damage the unit

### Insulation

RS232/485/CANbus/TTL:

> 100 MOhm @ 500 Vdc between all pins and case.

### Performance

There are two levels of performance specification:

- Standard
- Improved

Specifications include combined effects of non-linearity, hysteresis, repeatability and temperature errors over the compensated temperature range, and over the base pressure range of 35 mbar to the full scale pressure.

Accuracy Code	Precision
A1- Standard	0.02% FS
A2- Improved	0.01% FS

- For Frequency & Diode output, the above accuracies are achievable by using a polynomial curve fit algorithm and coefficient data supplied with sensor.
- Sensors are calibrated against standards traceable to UKAS operating to better than 100 ppm.

### Compensated Temperature Ranges:

There are four compensated temperature ranges available:

- -10 to +50°C
- -40 to +85°C
- -40 to +125°C (TTL, RS485 and CANbus only)
- -55 to +125°C (TTL, RS485 and CANbus only)

### Temperature Effects

All temperature effects are included in the accuracy statement.

### Long Term Stability

Standard: ±0.02% FS/annum

Improved: ±0.01% FS/annum

Note: Unless otherwise specified, specifications are at the reference conditions of 25°C (77°F) ±5°C (±9°F) and 1 bar (14 psi).

### Orientation (g) Sensitivity

Less than 0.2 mbar/g

## Physical Specifications

### Storage Temperature Range

As compensated temperature range.

### Operating Temperature Range

As compensated temperature range.

### Pressure Media

Fluids compatible with 316L stainless steel and gold.  
Do not use with oxygen rich media or other strong oxidizing agents. This product contains materials or fluids that may degrade or combust in the presence of strong oxidizing agents.

### Ingress Protection

See Electrical Connector section

### Vibration

BS EN 60068-2-6 (2008) Sine sweeps 5 Hz to 2 kHz, levels to 20gn

BS EN 60068-2-64 random 10 Hz to 2kHz to 4gn RMS for 1 hour each axis

Less than 0.02% FS effect at any time

### Shock

DO-160E 9 (Figure 7.2) 20 gn 11 ms terminal saw-tooth profile

### Humidity

MIL-STD-810D Method 507.2 Procedure III  
(Aggravated humidity environment, 65°C, 95% RH)

### Pressure Connector

Available Options are:

- G1/4 Female
- G1/4 Male Flat
- G1/4 Male 60° Internal Cone
- G1/8 Male 60° Internal Cone
- 1/4 NPT Female
- 1/4 NPT Male
- 1/8 NPT Male
- M20 x 1.5 Male (3mm bore)
- M14 x 1.5 60° Internal Cone
- M12 x 1 Internal Cone
- 7/16-20 UNJF Male 74° External Cone
- G1/2 Male
- G1/4 Quick Connect
- 1/2 NPT Male
- G1/4 Male Flat Long
- 7/16-20 UNJF Female
- 7/16-20 UNF Male Short Flat
- 3/8-24 UNJF
- 1/4 VCR Female
- 1/4 VCR Male

Other pressure connectors may be available. Contact Druck to discuss your requirement.

Please ensure that only the intended sealing face is used when mounting the sensor. Failure to comply with this requirement may affect performance or calibration accuracy.

Male threaded pressure connectors must not be sealed or constrained against the face at the base of the thread. The forward cone or flat face should always be used, as indicated below.

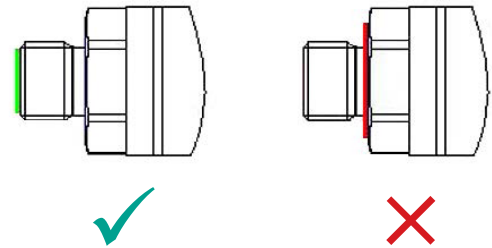

### Electrical Connector

Code No.	Description	Max Operating Temp. Range		IP Rating
		°C	°F	
0	No Connector	-55 to +125	-67 to +257	-
1	Cable Gland	-40 to +80	-40 to +176	65
2	Raychem Cable	-55 to +125	-67 to +257	65
6	Bayonet MIL-C-26482	-55 to +125	-67 to +257	*
C	1/2 NPT Conduit	-40 to +80	-40 to +176	65
G	M12 X "15"-pin	-55 to +125	-67 to +257	*
H	PTFE Cable (Orange)	-55 to +125	-67 to +257	54
U	USB-C socket	-40 to +85	-40 to +185	-

\* Hermetically sealed connectors with a maximum leak rate of  $1 \times 10^{-6}$  cc/s at 1 atmosphere. High IP rated mating connectors are available.

### Certifications

- CE Marked
- RoHS
- EMC Standards:
  - BS EN 61000-6-1: 2007, Susceptibility – Light Industrial.
  - BS EN 61000-6-2: 2005, Susceptibility – Heavy Industrial.
  - BS EN 61000-6-3: 2007, Emissions – Light Industrial.
  - BS EN 61000-6-4: 2007, Emissions – Heavy Industrial.
  - BS EN 61326-1: 2013, Electrical Equipment for Measurement, Control and Laboratory Use – EMC requirements.
  - BS EN 61326-2-3:2013 Requirements for pressure transducers.
- ATEX/IECEx/UKEX Ex ec nC IIC T3 Gc  
CSA Class I Division 2 Groups C,D T3  
(Canbus and M12 connector only).

## Connection Details

Electrical Connection	Connection	Function			
		Frequency & Diode	RS485	RS232	Digital – CANbus
Flying Leads	RED	SUPPLY +VE	+VE SUPPLY	+VE SUPPLY	SUPPLY +VE
	YELLOW	FREQ	RS485 B	Rx	CAN Hi
	GREEN	+VE TEMP	RS485 A	Tx	CAN Lo
	BLUE	GROUND	GROUND	GROUND	SUPPLY -VE
	WHITE/ORANGE	EEPROM	RS485 RT	-	-
	BLACK	-VE TEMP	-	-	CAN 0V

Electrical Connection	Connection	Function			
		Frequency & Diode	RS485	RS232	Digital – CANbus
Polyurethane cable	RED	SUPPLY +VE	+VE SUPPLY	+VE SUPPLY	SUPPLY +VE
	YELLOW	FREQ	RS485 B	Rx	CAN Hi
	BLUE	+VE TEMP	RS485 A	Tx	CAN Lo
	WHITE	GROUND	GROUND	GROUND	SUPPLY -VE
	ORANGE	EEPROM	RS485 RT	-	-
	BLACK	-VE TEMP	-	-	CAN 0V

Electrical Connection	Connection	Function			
		Frequency & Diode	RS485	RS232	Digital – CANbus
Raychem Cable	RED	SUPPLY +VE	+VE SUPPLY	+VE SUPPLY	SUPPLY +VE
	WHITE	FREQ	RS485 B	Rx	CAN Hi
	GREEN	+VE TEMP	RS485 A	Tx	CAN Lo
	BLUE	GROUND	GROUND	GROUND	SUPPLY -VE /CAN 0V
	BLACK	EEPROM	RS485 RT	-	-
	SCREEN	-	-	-	-

Electrical Connection	Connection	Function			
		Frequency & Diode	RS485	RS232	Digital – CANbus
Bayonet (MIL-C-26482)	A	SUPPLY +VE	+VE SUPPLY	+VE SUPPLY	SUPPLY +VE
	B	FREQ	RS485 B	Rx	CAN Hi
	C	+VE TEMP	RS485 A	Tx	CAN Lo
	D	GROUND	GROUND	GROUND	SUPPLY -VE
	E	EEPROM	RS485 RT	-	-
	F	-VE TEMP	-	-	CAN 0V

Electrical Connection	Connection	Function			
		Frequency & Diode	RS485	RS232	Digital – CANbus
M12 x 1	1	SUPPLY +VE	+VE SUPPLY	+VE SUPPLY	-
	2	FREQ	RS485 B	Rx	SUPPLY +VE
	3	GROUND	GROUND	GROUND	CAN Hi
	4	+VE TEMP	RS485 A	Tx	CAN Lo
	5	EEPROM	-	-	SUPPLY -VE /CAN 0V

Electrical Connection	Connection	Function			
		Frequency & Diode	RS485	RS232	Digital – CANbus
Orange PTFE Cable	RED	SUPPLY +VE	+VE SUPPLY	+VE SUPPLY	SUPPLY +VE
	YELLOW	FREQ	RS485 B	Rx	CAN Hi
	GREEN	+VE TEMP	RS485 A	Tx	CAN Lo
	BLUE	GROUND	GROUND	GROUND	SUPPLY -VE
	BLACK	EEPROM	RS485 RT	-	-
	WHITE	-VE TEMP	-	-	CAN 0V
	SCREEN	Transducer Body	Transducer Body	Transducer Body	Transducer Body

	Frequency & Diode	Digital – RS232	Digital – RS485	CANbus	USB <sup>1)</sup>
Maximum Cable length (m)	10	10	1000	1000	2

Note<sup>1)</sup>: Cable not provided with USB option.

## Dimensional Drawings

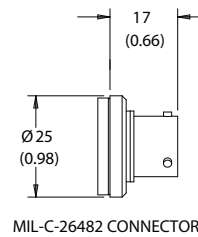
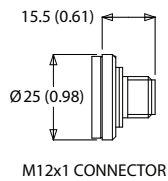
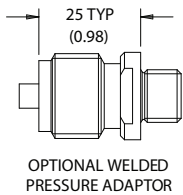
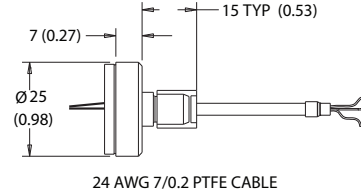
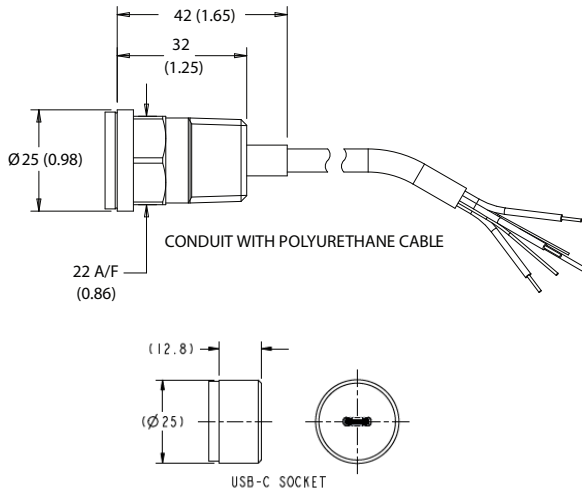
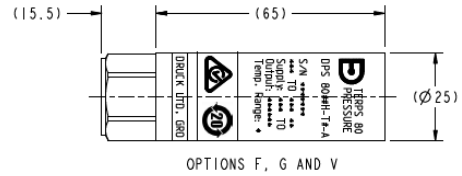
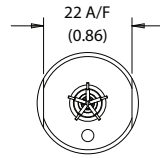
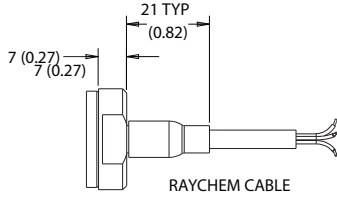
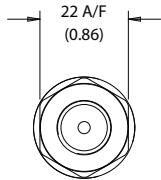
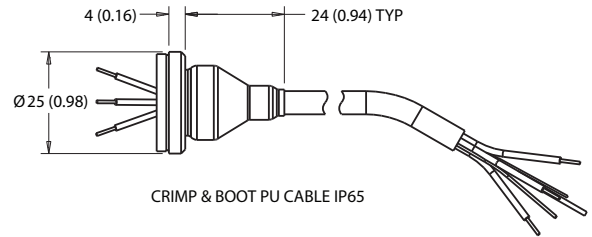
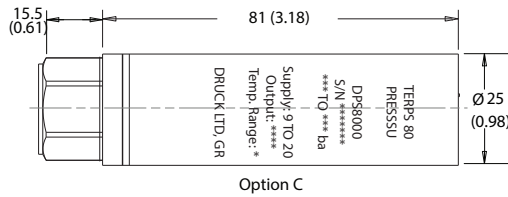
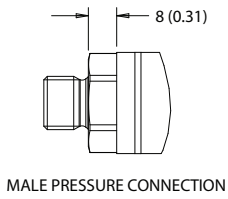

### Notes:

1. All dimensions are nominal lengths and are subject to change.
2. All dimensions are in millimeters (inches).
3. Other pressure and electrical connectors may be available, please contact Druck.

# Ordering information

## 1. Select model code

### Main Product Variant

RPS Resonant Pressure Sensor - Frequency & Diode Output (Note 1)  
 DPS Digital Pressure Sensor - Digital Output (Note 1)

#### Diameter, Material and Isolation

80 25mm Stainless Steel Oil isolated

#### Electrical Connector

0 No Electrical Connector (Flying leads length >100mm)  
 1 Polyurethane Cable IP65  
 2 Raychem Cable  
 6 MIL-C-26482 (6-pin Shell Size 10)  
 C 1/2" NPT Conduit with Polyurethane Cable (Non-Exd Only)  
 G M12x1 5-Pin  
 H Orange PTFE Cable  
 U USB-C socket (Note 3)

#### Output Option

I Frequency & Diode (TTL)  
 F RS485  
 G RS232  
 C CANbus  
 V USB 2.0 (Note 4)

#### Hydrogen Use

H

#### Compensated Temperature Range

TA -10 to +50 °C  
 TB -40 to +85 °C  
 TC -40 to +125 °C (Note 2)  
 TD -55 to +125 °C (Note 2)

#### Accuracy

A1 - Standard 0.02%  
 A2 - Improved 0.01%

#### Calibration

CC Full Thermal Calibration

#### Hazardous Area Approval

H0 None  
 HU IECEx/ATEX/C&US Ex ec nC (Note 5)

#### Pressure Connector

PA G1/4 Female  
 PB G1/4 Male Flat  
 PC G1/4 Male 60° internal Cone  
 PD G1/8 Male 60° internal Cone  
 PE 1/4 NPT Female  
 PF 1/4 NPT Male  
 PG 1/8 NPT Male  
 PH M20x1.5  
 PJ M14x1.5 60° Internal Cone  
 PK M12x1 Internal Cone  
 PL 7/16-20 UNJF Male 74 degree external cone  
 PN G1/2 Male  
 PQ G1/4 Quick Connect  
 PR 1/2 NPT Male  
 PT G1/4 Male Flat Long  
 PV 7/16-20 UNJF Female  
 PX 7/16-20 UNF Male Flat  
 PY 3/8-24 UNJF  
 RA 1/4 VCR Female  
 RF 1/4 VCR Male

**RPS 80 2 1 H - TA - A2 - CC - H0 - PA (Typical Model Code)**

Note 1: RPS variants require Output Option Code 'I'. DPS variants require Output Option Code 'F', 'G', 'C' or 'V'.

Note 2: Requires Output Option Code 'I', 'F' or 'C' and Electrical Connector Codes '0', '2', '6', 'G', or 'H'.

Note 3: Only available with USB output option.

Note 4: Only available with USB-C socket connector.

Note 5: Only available with electrical connector option G and CANbus output.

Note 6: Improved accuracy only available on pressure ranges greater than 2 bar.

## Ordering Information (cont.)

### 2. State pressure range and units (e.g., 0 to 20 bar, 0 to 100 psi):

Unit options are:

Symbol	Description
bar	bar
mbar	millibar
psi	pounds/sq. inch
Pa	Pascal
hPa	hectoPascal
kPa	kiloPascal
MPa	megaPascal
mmH <sub>2</sub> O	mm water
cmH <sub>2</sub> O	cm water
mH <sub>2</sub> O	metres water
inH <sub>2</sub> O	inches water
ftH <sub>2</sub> O	feet water
mmHg	mm mercury
inHg	inches mercury
kgf/cm <sup>2</sup>	kg force/sq. cm
atm	atmosphere
Torr	torr

### 3. State cable lengths and units e.g., 1 m cable, 3 ft cable (only required on certain electrical connectors):

*Note 6: Maximum Cable length: (I) Frequency & Diode – 10 m, (F) RS485 – 1000 m, (G) RS232 – 10 m, (C) CANbus – 1000 m. Integer values only, e.g. 1m (3 ft) cable. Minimum cable length is 1m (3 ft) if cable is supplied.*

#### Typical order examples:

RPS 8011H-TA-A1-CC-H0-PA, 0-7 bara, 5 m cable

DPS 806FH-TB-A2-CC-H0-PL, 0-1,000 psia

Druck offers a portfolio of high accuracy, high performance test and calibration equipment that are ideal for the calibration and adjustment of Druck's pressure sensors.

[Find out more at Druck.com](https://www.druck.com)



2026 Copyright by Druck Limited. All rights reserved.

920-713E

(03/2026)

BHCS39429A