

## 496 Series

### Position Transmitter and Limit Switch

IP and Low Voltage UK Instruction Manual (Rev. B)





THESE INSTRUCTIONS PROVIDE THE CUSTOMER/OPERATOR WITH IMPORTANT PROJECT-SPECIFIC REFERENCE INFORMATION IN ADDITION TO THE CUSTOMER/OPERATOR'S NORMAL OPERATION AND MAINTENANCE PROCEDURES. SINCE OPERATION AND MAINTENANCE PHILOSOPHIES VARY, BAKER HUGHES AND ITS SUBSIDIARIES AND AFFILIATES) DOES NOT ATTEMPT TO DICTATE SPECIFIC PROCEDURES, BUT TO PROVIDE BASIC LIMITATIONS AND REQUIREMENTS CREATED BY THE TYPE OF EQUIPMENT PROVIDED.

THESE INSTRUCTIONS ASSUME THAT OPERATORS ALREADY HAVE A GENERAL UNDERSTANDING OF THE REQUIREMENTS FOR SAFE OPERATION OF MECHANICAL AND ELECTRICAL EQUIPMENT IN POTENTIALLY HAZARDOUS ENVIRONMENTS. THEREFORE, THESE INSTRUCTIONS SHOULD BE INTERPRETED AND APPLIED IN CONJUNCTION WITH THE SAFETY RULES AND REGULATIONS APPLICABLE AT THE SITE AND THE PARTICULAR REQUIREMENTS FOR OPERATION OF OTHER EQUIPMENT AT THE SITE.

THESE INSTRUCTIONS DO NOT PURPORT TO COVER ALL DETAILS OR VARIATIONS IN EQUIPMENT NOR TO PROVIDE FOR EVERY POSSIBLE CONTINGENCY TO BE MET IN CONNECTION WITH INSTALLATION, OPERATION OR MAINTENANCE. SHOULD FURTHER INFORMATION BE DESIRED OR SHOULD PARTICULAR PROBLEMS ARISE WHICH ARE NOT COVERED SUFFICIENTLY FOR THE CUSTOMER/OPERATOR'S PURPOSES THE MATTER SHOULD BE REFERRED TO BAKER HUGHES.

THE RIGHTS, OBLIGATIONS AND LIABILITIES OF BAKER HUGHES AND THE CUSTOMER/OPERATOR ARE STRICTLY LIMITED TO THOSE EXPRESSLY PROVIDED IN THE CONTRACT RELATING TO THE SUPPLY OF THE EQUIPMENT. NO ADDITIONAL REPRESENTATIONS OR WARRANTIES BY BAKER HUGHES REGARDING THE EQUIPMENT OR ITS USE ARE GIVEN OR IMPLIED BY THE ISSUE OF THESE INSTRUCTIONS.

THESE INSTRUCTIONS ARE FURNISHED TO THE CUSTOMER/OPERATOR SOLELY TO ASSIST IN THE INSTALLATION, TESTING, OPERATION, AND/OR MAINTENANCE OF THE EQUIPMENT DESCRIBED. THIS DOCUMENT SHALL NOT BE REPRODUCED IN WHOLE OR IN PART TO ANY THIRD PARTY WITHOUT THE WRITTEN APPROVAL OF BAKER HUGHES.

# Table of Contents

<b>1. Important Safety Instruction .....</b>	<b>6</b>
<b>2. Instrument Operation .....</b>	<b>7</b>
2.1. The 496-.55 position limit switch(es) .....	7
2.2. The 496-855/. and 496-855 position transmitter with and without limit switch(es) .....	7
<b>3. Numbering System.....</b>	<b>7</b>
<b>4. Marking.....</b>	<b>8</b>
<b>5. Electrical Characteristics.....</b>	<b>9</b>
5.1. 496 types concerned by UK Electrical Equipment (Safety) Regulations 2016 .....	9
5.2. 496 types not concerned by UK Electrical Equipment (Safety) Regulations 2016.....	10
<b>6. Electrical Connection, Installation and Start-up.....</b>	<b>11</b>
6.1. Cable gland .....	11
6.2. Cable .....	11
6.3. Supply source for type 496-•55 .....	12
6.4. Electrical connections rules for type 496-•55 .....	12
6.5. Electrical connections for type 496-855/• .....	13
6.6. Electrical Terminal Connections and Schematic.....	14
6.7. Start-up .....	15
<b>7. Calibration.....</b>	<b>16</b>
7.1. Calibration of mechanical limit switch 496-155, 496-255 .....	16
7.2. Calibration of proximity limit switch 496-.55 .....	18
7.2.1. Type 496-455 .....	18
7.2.2. Type 496-555 .....	18
7.2.3. Air-gap adjustment .....	19
<b>8. Risk Assessment.....</b>	<b>22</b>
<b>9. Maintenance.....</b>	<b>24</b>
<b>Annex I - Cable and Adaptor - Reducer Mounting Rules .....</b>	<b>25</b>
<b>Annex II - Y237 Adaptor - Mounting Rules .....</b>	<b>26</b>
<b>Annex III - Switch Configuration .....</b>	<b>27</b>

# Warning

BEFORE installing, using or carrying out any maintenance tasks associated with this instrument, **READ THE INSTRUCTIONS CAREFULLY.**

These instruments comply with UK Electrical Equipment (Safety) Regulations 2016 (S.I. 2016 No. 1101).

They also comply to the Electromagnetic Compatibility Regulations 2016 (S.I. 2016/1091).

All those instruments are covered by a IP66/67 protection mode and a certificate of conformity **INERIS-025816-14.**

## Products **MUST BE:**

a) Installed, put into service, used and maintained in compliance with UK Electrical Equipment (Safety) Regulations 2016 (S.I. 2016 No. 1101) concerning electrical equipment designed for use within certain voltage limits.

b) Used only in situations those comply with the conditions of use shown in this document and after verification of their compatibility with the area of intended use and the permitted maximum ambient temperature.

c) Installed, put into service and maintained by qualified and competent professionals who have undergone suitable training for electrical installation. Such trainings are not supported by Baker Hughes.

## It is the end user's responsibility to:

- Verify material compatibility with the application
- Ensure proper use of fall protection when working at heights, per Safe Site Work Practices
- Ensure use of proper Personal Protective Equipment
- Take the appropriate actions to ensure that site personnel who are performing installation, commissioning and maintenance have been trained in proper site procedures for working with and around equipment, per Safe Site Work Practices

**Baker Hughes reserves the right to discontinue manufacture of any product or change product materials, design, or specifications without notice.**

Under certain operating conditions, the use of damaged instruments could cause a degradation of the performances of the system which may lead to personal injury or death.

Use only Baker Hughes Masoneilan replacement parts to ensure that the products comply with UK Electrical Equipment (Safety) Regulations 2016 (S.I. 2016 No. 1101).

# 1. Important Safety Instruction

- The 496 series can be installed at a maximum altitude up to 4000 meters indoor or outdoor.
- The maximum operating temperature range is: -55°C to +85°C and can be reduced depending on the type of detector.
- The relative humidity non-condensing can be up to 95% on the operating temperature range.
- The 496 series has a weatherproof protection of IP66/67 according to **EN IEC 60529**.
- The degree of pollution is 2 and the environmental situation is C.
- Voltage fluctuations can be +/-10% of the nominal voltage.
- The transient overvoltage is defined category II.
- The user will have to check the temperature increase on the 496 series (coming from conduction with mechanical part in contact with the 496 housing or through the process thermal radiation) to be less or equal than the maximum admissible temperature of the instrument.
- Installed, put into service, used and maintained in compliance with UK Electrical Equipment (Safety) Regulations 2016 (S.I. 2016 No. 1101) concerning electrical equipment designed for use within certain voltage limits.
- Installed, put into service and maintained by qualified and competent professionals who have undergone suitable electrical accreditation.
- Installed on valve actuators using genuine Masoneilan mounting kits defined in the standard instruction manual and completed by mounting drawings for special applications.
- Risk of electric shock – do not open unless the power is turned off.
- Do not expose internal parts of 496 series to rain. If the interior gets wet from accident, the device can no longer be considered operational and must be disassembled either to be reconditioned or destroyed.
- Do not expose internal parts of 496 series to dust. If the interior becomes soiled with accident, the device can no longer be considered operational and must be disassembled either to be reconditioned or destroyed.
- Definition of below symbols marked on the 496 series:



**Caution. Risk of Danger** (ref ISO 7000-0434B).

This symbol indicates a safety point of attention. This means the user must read this document first before any action on the device.



**Caution, possibility of electric shock.**

This symbol indicates the presence of dangerous voltages inside this product.

To avoid any risk of electric shock, never put your fingers inside the device without checking that the power supplies of the various electrical circuits are cutoff.



This symbol indicates **documentation relating to the operation and maintenance is supplied with the product.**



**Protective conductor terminal** (IEC 60417-5019).



**Earth (ground) terminal** (IEC 60417-5017).



**Direct current** (IEC 60417-5031).



**Alternating current** (IEC 60417-5032).

## 2. Instrument Operation

### 2.1. The 496-.55 position limit switch(es)

Allow switching 1 to 2 electrical circuits. This function is provided by 1 or 2 micro-switch(es) or 1 or 2 proximity switch(es) for **496-.55**. This device can be mounted on both rotary and reciprocating valves.

### 2.2. The 496-855/. and 496-855 position transmitter with and without limit switch(es)

**496-855** is a non-contact opto-electronic position transmitter which provides a 4-20mA analog output signal proportional to the valve position. The opto-electronic sensor has the same function than a standard potentiometer and its output voltage is proportional to the rotation of its axis.

An electronic circuit amplifies this voltage to a 4-20 mA signal proportional to the angle of rotation. This equipment has many advantages:

- non-electrical noise typical of potentiometer with cursor
- frictionless
- unlimited life
- non-sensitive to vibration and electrical noise
- very low operating torque: 0.02 N.m.

This device can be both mounted on rotary and reciprocating valves.

**496-855/.** allow switching electrical circuits with 1 or 2 micro-switch(es) or 1 or 2 proximity switch(es) in addition to a non-contact opto-electronic position transmitter which provides a 4-20mA analog output signal proportional to the valve position.

This device can be both mounted on rotary and reciprocating valves.

## 3. Numbering System

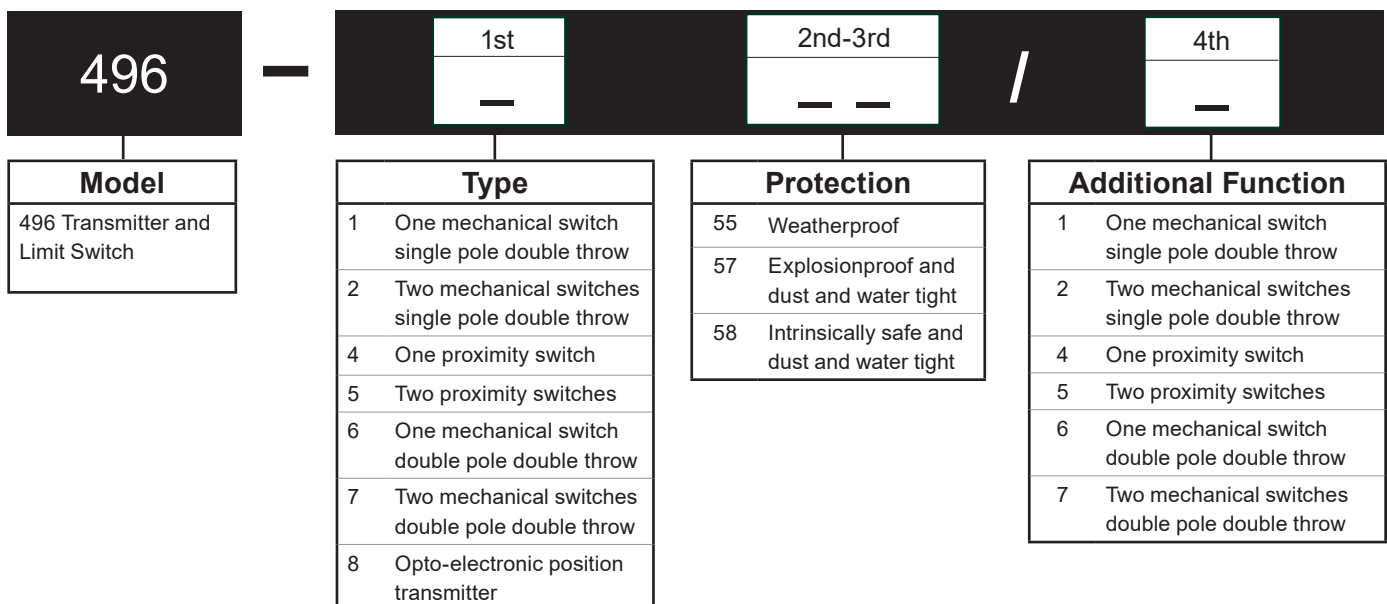

## 4. Marking

The marking is on the serial plate stamped on the 496 cover (14).

- Name and address of the manufacturer  
Dresser Produits Industriels S.A.S.  
14110 CONDE SUR NOIREAU – FRANCE
- Type designation:
  - **496-•55** for position switches  
The • can be replaced by **1, 2, 4, 5, 6, 7**
  - **496-855** for position transmitter
  - **496-855/•** for position transmitter with additional function(s)  
The • can be replaced by **2, 7**
- Specific marking: IP66/67 with certification of conformity
- Maximum rating for voltage and current
- Maximum temperature range
- Serial number
- Year of manufacturing
- Warning and symbol:

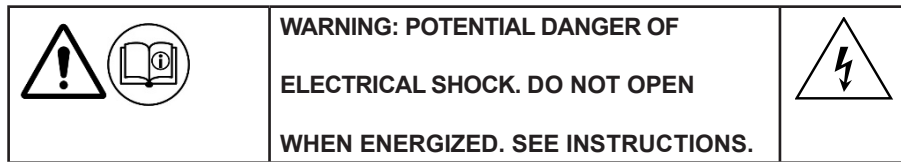

- Conformity UKCA logo





## 5. Electrical Characteristics

### 5.1. 496 types concerned by UK Electrical Equipment (Safety) Regulations 2016

The UK Electrical Equipment (Safety) Regulations 2016 (S.I. 2016 No. 1101) is applicable to all instruments with a nominal voltage between 50V up to 1000V for an alternative current, and 70V up to 1500V for a continuous current.

The table below lists the 496 types for which the UK Electrical Equipment (Safety) Regulations 2016 is applicable and shows the maximum values in voltage or current for those 496 types.

Please refer to the manufacturer datasheet for complementary information.



Type	Detector Model	Manufacturer	Electrical Values	Connection
<b>496-655</b> <b>496-755</b>	DT-2R-A7	Honeywell	0.15A & 250Vdc == 10A & 250Vac~ @ 50/60Hz	On board
<b>496-155</b> <b>496-255</b>	1HS1	Honeywell	0.5A & 120Vdc == 1A & 115Vac~ @ 50/60Hz	On board
<b>496-155</b> <b>496-255</b>	BZ-2R-72-A2	Honeywell	1A & 125Vac~ @50/60Hz	On board
<b>496-255</b>	BZ R-A2	Honeywell	15A & 125Vac~ @ 50/60Hz 15A & 250Vac~ @ 50/60Hz	On board
<b>496-455</b> <b>496-555</b>	XS612B1MAL2	Schneider Electric	0.2A & 240Vdc == 0.2A & 240Vac~ @50/60Hz	Weidmuller connector
<b>496-455</b> <b>496-555</b>	Bi2S12AZ31X/S97	Hans Turck GmbH & Co.KG	0.1A & 300Vdc == 0.1A & 250Vac~ @50/60Hz	Weidmuller connector
<b>496-455</b> <b>496-555</b>	Bi5S18AZ3X/S97	Hans Turck GmbH & Co.KG	0.3A & 300Vdc == 0.4A & 250Vac~ @50/60H	Weidmuller connector
<b>496-855/2</b>	Opto-electronic sensor with additional switch(es): BZ R-A2 or 1HS1 or BZ-2R-72-A2	Baker Hughes & Switches Manufacturers	Output current 4-20mA (two wires) 4-20mA @ 9 to 36Vdc == Zero range adjustment: ±0.5mA Span range adjustment: ±2.5mA See above for switch(es) electrical values	On electronic board
<b>496-855/7</b>	Opto-electronic sensor with additional switch(es): DT-2R-A7	Baker Hughes & Switches Manufacturers	Output current 4-20mA (two wires) 4-20mA @ 9 to 36Vdc == Zero range adjustment: ±0.5mA Span range adjustment: ±2.5mA See above for switch(es) electrical values	On electronic board

## 5.2. 496 types not concerned by UK Electrical Equipment (Safety) Regulations 2016

The table below shows the voltage range of those 496 types.

Please refer to the manufacturer datasheet for complementary information.

Type	Detector Model	Manufacturer	Electrical Values	Connection
<b>496-455</b> <b>496-555</b> <b>496-855/4</b> <b>496-855/5</b>	NBB2-12GM40-Z0	Pepperl+Fuchs Group	8,2Vdc == @ ≤1mA or ≥3mA  5 to 60Vdc == @ 2 to 100mA  10 to 60Vdc == @ 0 to 100mA	Weidmuller connector
	NBN4-12GM40-Z0			
	NCB2-12GM35 NO			
	NCB2-12GM40-Z0			
	NCB5-18GM40 NO			
	NCB5-18GM40-Z0			
	NJ2-11N-G			
	NJ2-11SN-G			
	NJ2-12GK-N			
	NJ2-12GK-SN			
	NJ2-12GM40-E2			
	NJ2-12GM-N			
	NJ3-18GK-S1N			
	NJ4-12GK40-E2			
	NJ4-12GK-N			
	NJ4-12GK-SN			
NJ5-18GK-N				
NJ5-18GK-SN				
NJ5-18GM-N				
NJ5-30GK-S1N				
<b>496-455</b> <b>496-555</b> <b>496-855/4</b> <b>496-855/5</b>	XS512B1DAL2	Schneider Electric	12 to 48Vdc == @ 1,5 to 100mA	Weidmuller connector
	XS518B1DAL2			
<b>496-855</b>	OPTO	Baker Hughes	9 to 36Vdc == @ 4-20mA	On board

## 6. Electrical Connection, Installation and Start-up



- Comply with current national and local regulations for electrical installation work.
- Before carrying out any work on the device, power off the instrument for safe opening of the cover.
- Connect the wires to the instrument terminals, taking care of complying with polarities and maximum voltage allowed.
- Before power up or after doing any work on the device, always check:
  - O-ring (10) is free of any damage
  - the insulator (16) is well in place and covers the wiring connections for types 496-155, 496-255
  - the cover (12) is fully screwed and security screw (9) is well locked
  - Inside housing and cover are free of any humidity or dust
  - Check the earth terminals (internal and external) are well connected

**Note:** Before installation, check that the device is undamaged. In the event of damage, inform the manufacturer whose address is shown on the serial plate.

### 6.1. Cable gland

The connections can be done with different variations considering:

- A cable gland certified IP66/67 can be mounted directly on the single 3/4" NPT (ANSI/ ASME B1.20.1) housing conduit connection
- Use preferred metal construction for robustness (type aluminum, stainless steel, bronze, nickel-plated brass)
- Use cable gland with an external clamping module to provide additional mechanical strength for cable strain relief

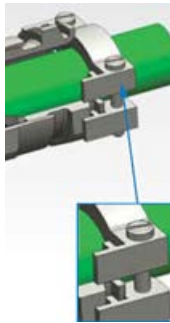

- Use grounding/armoured technology associated to shield cable for EMC purpose. Follow the manufacturer requirements for the mounting and the torque to apply on all parts screwed
- It must be compatible with the minimum and maximum ambient temperatures mentioned on the 496 serial plate
- Adaptor or reducer are allowed
- For multiple cable entries (3 maximum), the Masoneilan adaptor Y237 can be used
- The cable gland with or without its adaptor/reducer and the Y237 with its cable gland must be installed in conformance with Annex I & II

### 6.2. Cable

The cable must be selected to meet the following criteria:

- Raising temperature due to current crossing in the wires
- Insulation protection for the maximum voltage
- Flammability with a rating UL 2556 VW-1 or equivalent
- EMC immunity with shielded technology and twisted wiring

- The maximum upper operating temperature must be 9°C above the temperature mentioned on the 496 serial plate
- When the ambient temperature is lower than -20°C, to choose a cable compatible with the lowest possible ambient temperature. For reminder, 496-.55 and 496-.55/. series are certified up to -55°C, depending the type of detectors
- The external cable diameter must be compatible with the cable gland inlet to insure an IP66/67 protection
- The cable must enter in the cable gland without sharp bends and with a reliably fixed flexible cord guard made of insulating material protruding beyond the inlet opening by at least five times the overall diameter of a cord with the largest cross-sectional

### 6.3. Supply source for type 496-55



- A switch (30mA @ 60A) or a circuit-breaker (30mA @ 16A) is mandatory as means for supply source disconnection for each circuit. In case of two circuits using the same power voltage the circuit-breaker must be rating accordingly to the maximum current so 2 x 16 A. This concerns detectors DT-2R-A7 and BZ-R-A2
- It must be suitably located and easily reached
- It must be marked as the disconnecting device for the equipment
- The circuit-breaker must meet the relevant requirements of IEC 60947-2 and be suitable for the application
- The switch must meet the relevant requirements of IEC 60947-3 and be suitable for the application
- The switch or the circuit-breaker used as a disconnecting device must be marked to indicate this function. If there is only one device (one switch or one circuit-breaker) – symbols below are sufficient if the symbols are marked on or adjacent to the switch or circuit-breaker

Symbol	Reference	Description
	IEC 60417-5007	On (Power)
○	IEC 60417-5008	Off (Power)

### 6.4. Electrical connections rules for type 496-55

- The electrical cables are connected either directly on to the micro-switch(es) or to the proximity switch(es) terminal block using ONLY the type of terminals below to meet secure requirements.



- Micro-switch(es) connections between cable wires and detector terminals:

Solution 1	Insulated eyelet terminal crimped on the wire and screwed on the micro-switch terminals. Screw until the parts come into contact, then tighten firmly.	
Solution 2	Insulated spade connector crimped on the wire and plugged on the male terminal.	
	Male terminal screwed on the micro-switch terminals. Screw until the parts come into contact, then tighten firmly.	

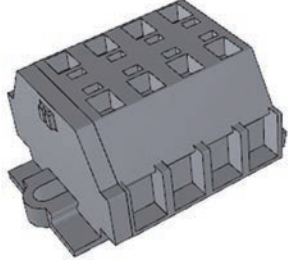
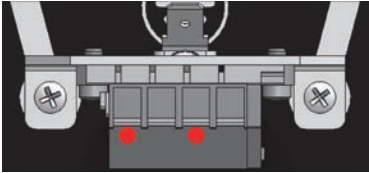
- Proximity switch(es) connections on the terminal block for both detector and cable wires:

	<p>Wires sizes from 0.33mm<sup>2</sup> to 4 mm<sup>2</sup> (AWG 28 to 14).          Wires type solid 0.5mm<sup>2</sup> to 4mm<sup>2</sup>          Wires type stranded 1.5mm<sup>2</sup> to 2.5mm<sup>2</sup>          Wires type fine-stranded 0.5mm<sup>2</sup> to 2.5mm<sup>2</sup>          Stripping length 8 to 9mm.</p>
	<p>Red point indicate the “+”.</p>

- Basic rule for wiring:
  - Must be used in addition to local regulation for electrical installation
  - The conductor insulation must be free of any damage inside the housing (no crushing, cutting)
  - Stripping of the conductors must be limited to flush with the metal connection part of the terminal, in order to guarantee insulation conditions.



CORRECT stripping and connection	INCORRECT stripping and connection	
		

- Connect the cable ground wire to the protective conductor terminal (⊥) inside the housing. It is recommended to use the Solution 2 listed in § 6.4.
- An external earth (ground) terminal (⊥) is also available on the device. Protective conductor and earth terminals are mechanically connected.

### 6.5. Electrical connections for type 496-855/•

- Connect the electrical cables to the position transmitter terminal block located on the printed circuit board. Respect the polarities + and – and the maximum voltage allowed. See Section 7.3.
- When a position transmitter is provided with an additional function, the electrical cables are connected either directly on to the micro-switch(es) or to the proximity switch(es) terminal block as defined in Section 6.4.

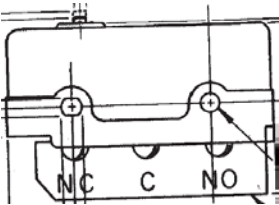
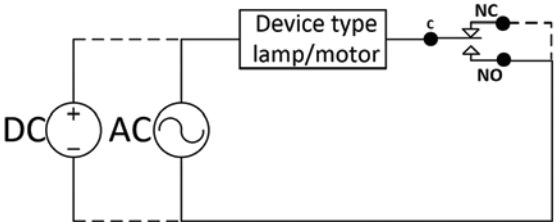
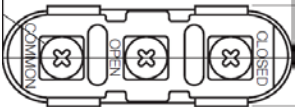
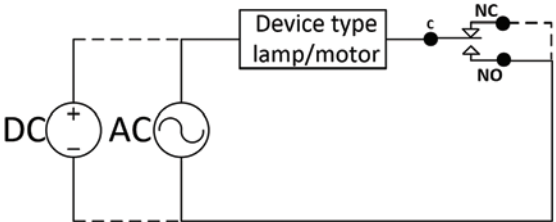
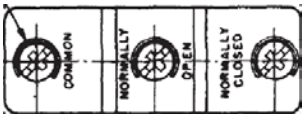
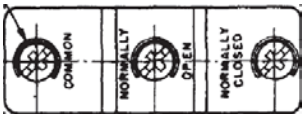
## 6.6. Electrical Terminal Connections and Schematic

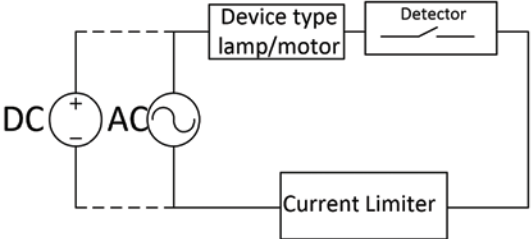
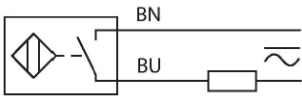
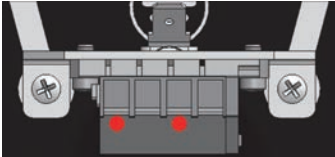
Type	Detector Model	Terminal	Raw Electrical schematic Without protection
496-655 496-755	DT-2R-A7		<p>NO: Normally Open NC: Normally Closed C: Common</p> 
496-155 496-255	1HS1		
496-155 496-255	BZ-2R-72-A2		
496-255	BZ R-A2		
496-455 496-555	XS612B1MAL2	<p>2 wires not polarised (BN/BU) Connector for 2 x detectors</p> 	
496-455 496-555	Bi2S12AZ31X/S97	<p>2 wires polarised (BN/BU) Connector for 2 x detectors</p> 	
496-455 496-555	Bi5S18AZ3X/S97		
496-855/2	Opto-electronic sensor with additional switch(es): BZ R-A2 or 1HS1 or BZ-2R-72-A2	See above for switch(es)	See above for switch(es)
496-855/7	Opto-electronic sensor with additional switch(es): DT-2R-A7	See Section 7.3 for Opto-electronic sensor	See Section 7.3 for Opto-electronic sensor

## 6.7. Start-up



**Before power up or after doing any work on the device, always check:**

- **O-ring (10) is free of any damage**
- **the insulator (16) is well in place and covers the wiring connections for types 496-155, 496-255**
- **the cover (12) is fully screwed and security screw (9) is well locked**
- **Inside housing and cover are free of any humidity or dust**

Before start-up, proceed, if required, with instrument calibration as per Section 7 and/or ensure that all the safety instructions in the preceding paragraphs have been strictly followed.

# 7. Calibration



Before proceeding to calibration, carefully read the following safety warnings and dedicated warning to each model:

- Comply with current national and local regulations for electrical installation work
- Before carrying out any work on the device, power off the instrument
- Connect the wires to the instrument's terminals, taking care of complying with polarities and maximum voltage allowed
- Before power up, after calibration process done or after doing any work on the device, always check:
  - O-ring (10) is free of any damage
  - the insulator is well in place and covers the wiring connections for types 496-155, 496-255
  - the cover (12) is fully screwed and security screw (9) is well locked
  - Inside housing and cover are free of any humidity or dust

## 7.1. Calibration of mechanical limit switch 496-155, 496-255



Before proceeding to calibration, carefully read the following safety warnings:

- Perform a pre-calibration power off  
Pre-set mechanical part as cam, lever
- Fine calibration or final check can be done power on under the minimum and not limited following conditions, and in application with local regulations:
  - the insulator is well in place and covers the wiring connections
  - action limited to cam adjusting using tools with full insulation on their metal parts
  - cover (12) can be screwed ONLY with power OFF

- The concave portion of the lever (5) must be strictly concentric to the cam (13) when the micro-switch is actuated.
- This is an important caution to make sure the lever is properly depressed when not actuated.
- If not, loosen the screws (3 & 17) and slightly move the lever upwards or downwards. Tighten the screws.
- Slightly loosen the cam locking screw (1) using a 3/32" socket hex head wrench.
- Move the plug stem to the position required to actuate the switch.
- It is important to note that the cam operating the right-hand micro-switch must actuate the lever (5) at the end of the counterclockwise rotation. (See detail figure below).
- This makes sure the screw (2) has free the lever (5) when the valve is throttling. The remaining concave portion only ensures micro-switch actuation in case of over travel. Conversely, the cam operating the left-hand micro-switch must actuate the lever (5) at the end of the clockwise rotation. (See front view below).
- When only one micro-switch is provided (type 496-158), it may be required to change the location of the micro-switch to meet the above requirements.
- Rotate the cam (13) until the micro-switch is actuated. Lock the cam (13) tightening the screw (1).
- Fine tune adjustment with screw (2). Use a 1/16" socket hex head wrench. The screw (2) must come out the cam enough to properly depress the lever (5).
- **Strictly follow safety instructions under Section 6.7 before putting into service.**



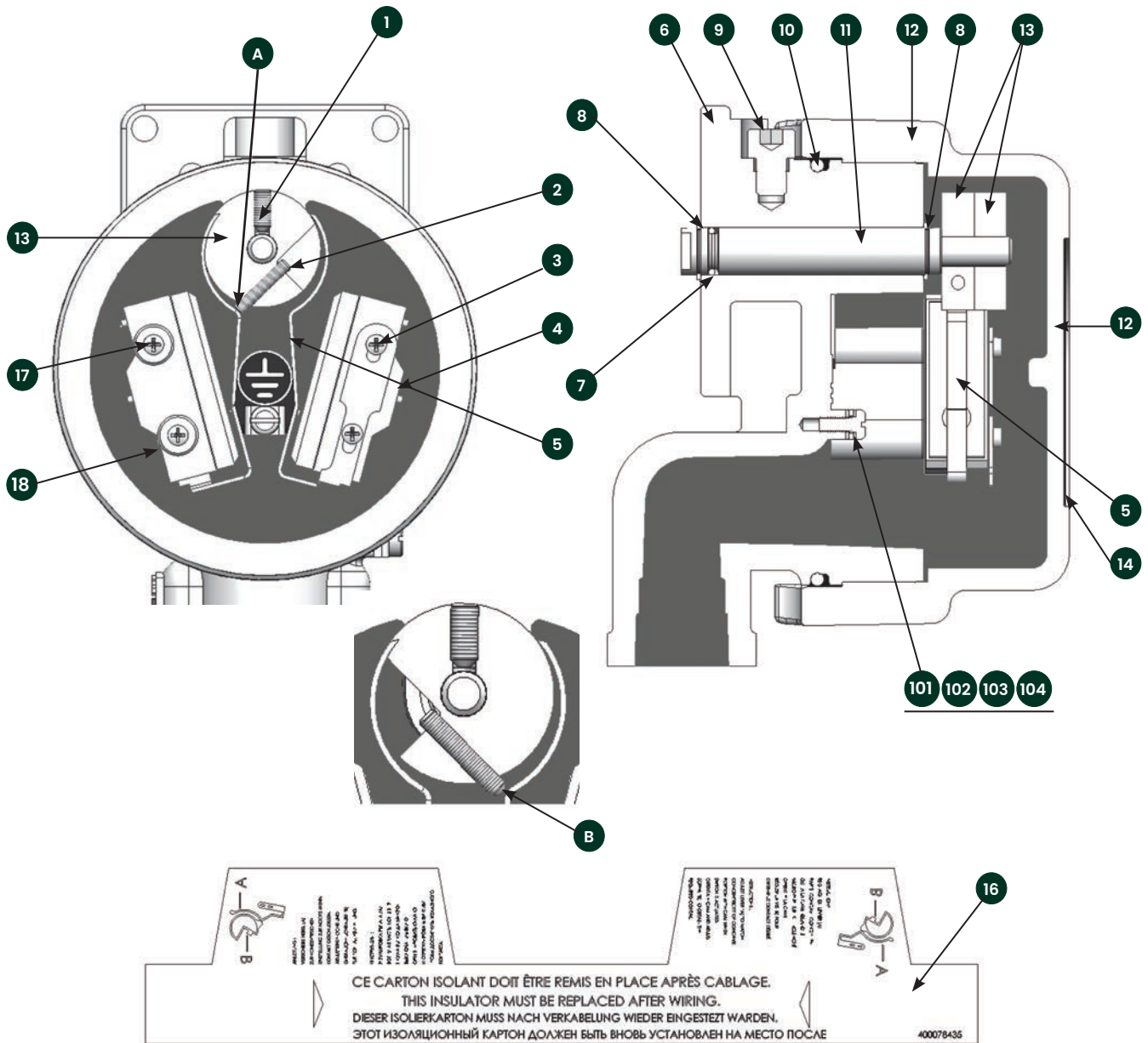

## Parts List

Ref. No.	Description	Ref. No.	Description	Ref. No.	Description
1	Screw	8	Snap ring	16	Insulating
2	Adjusting screw	9	Safety screw	17	Screw (second micro-switch)
3	Screw (1 micro-switch)	10 <sup>(1)</sup>	O-ring	18	Washer
4	Micro-switch	11	Axis	A	Contact point for the left micro-switch
5	Lever	12	Cover	B	Contact point for the right micro-switch
6	Housing	13	Cam		
7 <sup>(1)</sup>	O-ring	14	Serial plate		

(1) Recommended spare parts

## 7.2. Calibration of proximity limit switch 496-.55



Before proceeding to calibration, carefully read the following safety warnings:



- Perform a pre-calibration power off.

Pre-set mechanical part as cam, lever.

- Fine calibration or final check can be done power on under the minimum and not limited following conditions, and in application with local regulations:
  - the insulator is well in place and covers the wiring connections
  - action limited to cam adjusting using tools with full insulation on their metal parts
  - cover (12) can be screwed ONLY with power OFF

### 7.2.1. Type 496-455

- Actuate the valve to the desired triggering position and check the sense of rotation when the arm leaves the proximity sensor.
- The figure below shows the location of the proximity sensor and of the arm when triggering as a function of the sense of rotation.
- Slowly move the arm towards the proximity sensor until it triggers. Triggering occurs when the arm overlaps approximately 1/3 of the proximity switch.
- **Strictly follow safety instructions under Section 6.7 before putting into service.**

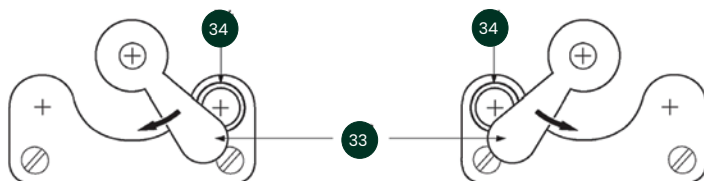

Ref. No.	Description	Ref. No.	Description
33	Arm	34	Proximity switch

### 7.2.2. Type 496-555

During adjustment, make sure that the proximity switch with the red spot is triggered by the arm with the red spot.

- Adjustment of the first proximity switch:
  - The first switch is adjusted at the beginning of the stroke.
  - Check what will be the sense of rotation when the valve is actuated. Figure (b, c) below shows the proximity sensor and the arm assigned to the first triggering point for a given sense of rotation.
  - Slowly move the arm towards the proximity switch until it triggers.
- Adjustment of the second proximity switch:
  - The second switch is adjusted at the end of the actuator stroke.
  - Immobilize the first arm previously adjusted and slowly move the second arm towards the second proximity sensor until it triggers.
  - Make sure the first proximity switch is still correctly adjusted.
- **Strictly follow safety instructions under Section 6.7 before putting into service.**

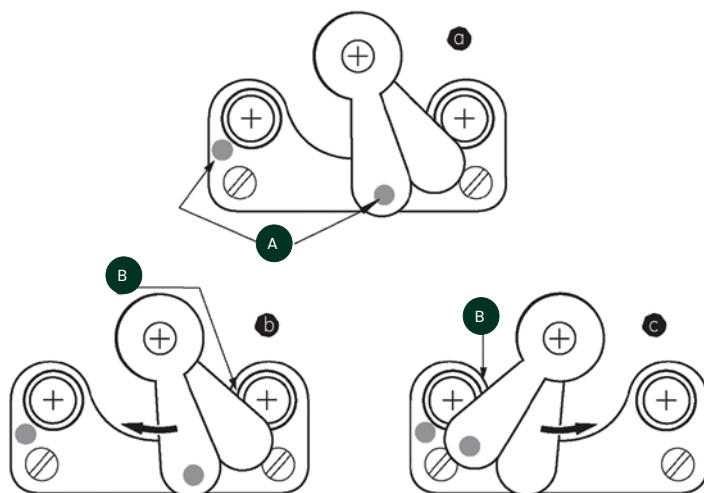

Ref. No.	Description	Ref. No.	Description
A	Red spot	B	First triggering point

### 7.2.3. Air-gap adjustment

Air-gap between the proximity switch and the arm is factory adjusted. If new adjustment is required, proceed as follows:

- Loosen the proximity sensor nut (37A), located on the front of the bracket (36).
- Unscrew a few turns the locknut (37B) located on the back of the bracket.

- Position the arm above the proximity sensor and push the shaft end (11) towards the outside of the housing so as to eliminate the longitudinal play.
- Hold in position the proximity sensor and screw the nut (37A). Adjust air gap to 0,3 mm using a shim
- Tighten the lock nut (37B).

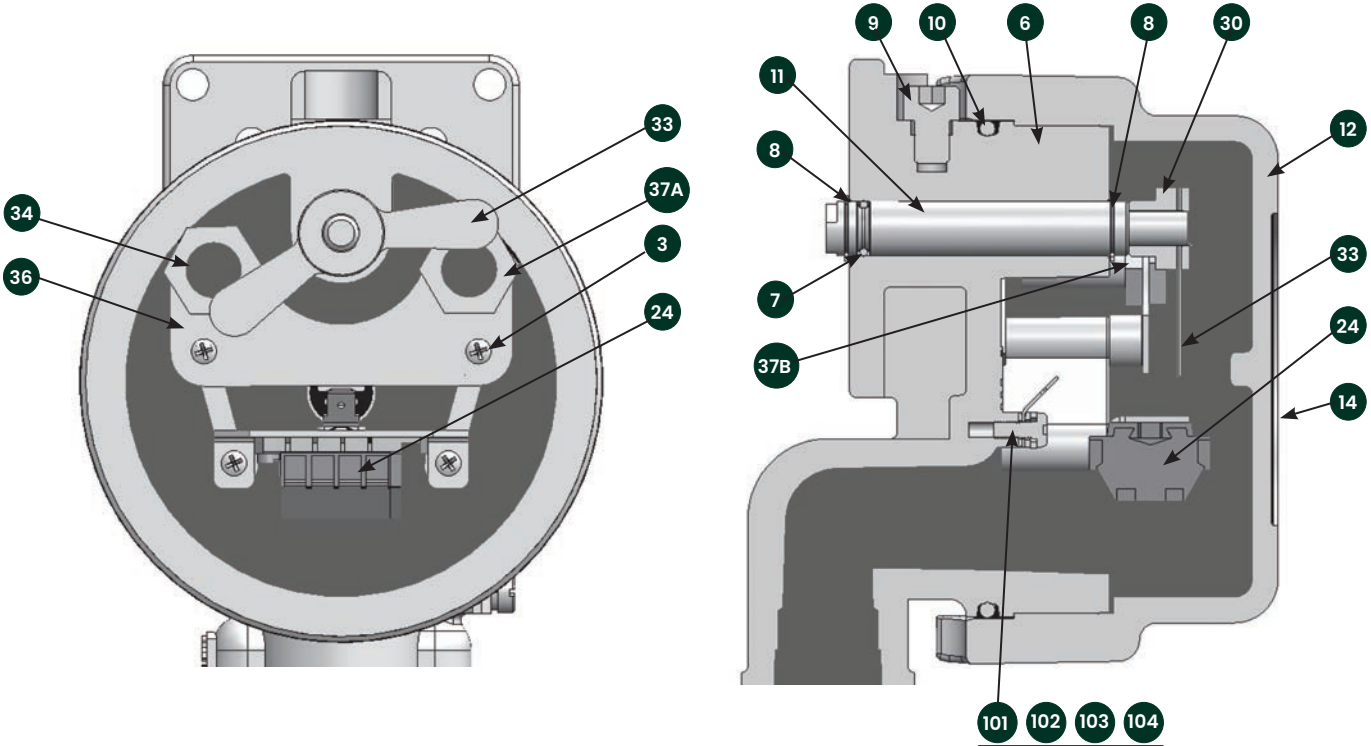

### Parts List

Ref. No.	Description	Ref. No.	Description	Ref. No.	Description
3	Screw	11	Axis	33	Arm
6	Housing	12	Cover	34	Proximity sensor
7 <sup>(1)</sup>	O-ring	14	Serial plate	36	Sensor bracket
8	Snap ring	24	Terminal block	37A	Top nut
9	Safety screw	30	Spacer	37B	Back nut
10 <sup>(1)</sup>	O-ring				

(1) Recommended spare parts

### 7.3 Calibration of position transmitter 496-855/• with additional functions



**Power off restriction is not requested as the position transmitter ALONE is out of UK Electrical Equipment (Safety) Regulations 2016 (S.I. 2016 No. 1101).**

#### • Valve action

The action sense of the valve (open or closed valve, compared to the 4 - 20 mA of the loop signal), determines the position of the connector 3 points of the opto-electronic sensor on one of the two connectors of electronic circuit A or B.

The operation rule is: for a clockwise rotation of the pinion of the control shaft (view cover side), the output current increases (4→20 mA) when the connector of the opto-electronic sensor is connected in A and decreases when connected in B.

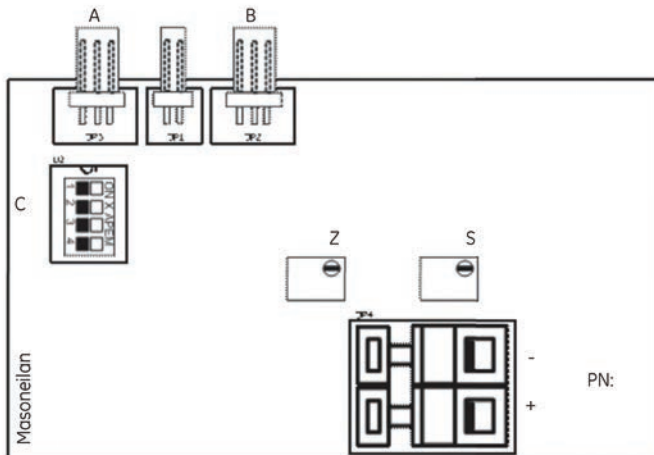

#### • Linkage adjustment

When mounted on reciprocating valves, adjust the turnbuckle to get the instrument lever perpendicular to the plug stem at mid-travel.

#### • Position transmitter adjustment

- Position the connector 3 points on connector A or B in function of the chosen action.
- Preset mid travel the zero adjustment (Z) if necessary\*.
- Preset mid travel the span adjustment (S) if necessary\*\*.
- Configure the switch C (see Annex III) on the rotation angle of the control valve.

- Position the valve to the origin of travel that should correspond to the minimum of the signal (4 mA).
- Install a milliamp meter in series in the loop and power up the instrument.
- Rotate the primary pinion on the control axle to get an output signal around 4 mA.
- Fine tune-up of the 4 mA signal with the zero potentiometer (Z).
- Full stroke the valve to the rated travel and adjust the output signal to 20 mA with the span potentiometer (S).
- Check the zero and span calibration compared to the valve stroke. Repeat the zero and span calibration operations if necessary.

\* In case of problem of Zero adjustment due to the physical limits of the potentiometer, turn of 5 turns in the reverse direction than desired and turn the primary pinion to obtain an output current nearest to 4 mA.

\*\* In case of problem of span adjustment due to the physical limits of the potentiometer, turn of 5 turns in the reverse direction than desired and configure the switch C (see Annex IV) for a higher or lower angle than that basis.

- **Adjustment of micro-switch(es) or proximity switch(es)**  
Refer to Section 6.3 to adjust micro-switch(es) or proximity switch(es).
- **Strictly follow safety instructions under Section 6.7 before putting into service.**

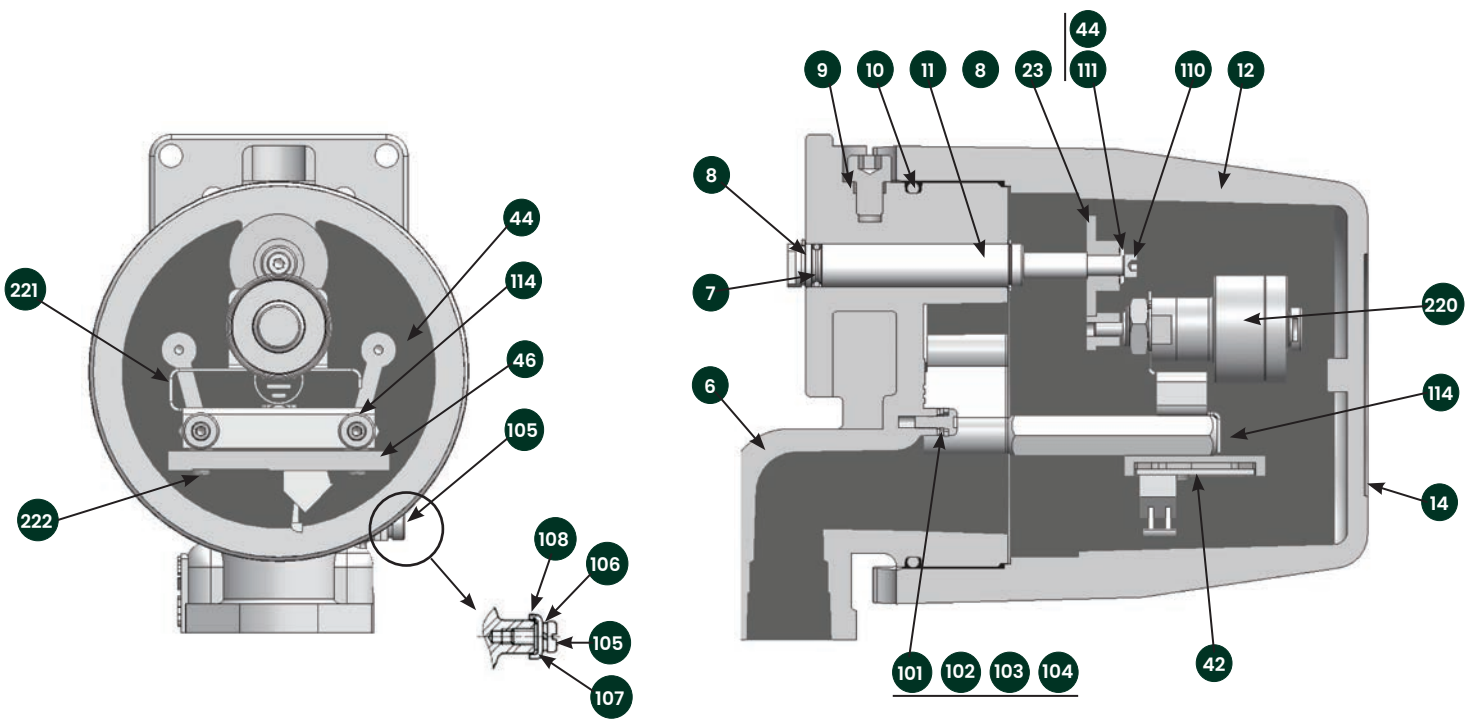

## Parts List

Ref. No.	Description	Ref. No.	Description	Ref. No.	Description
6	Housing	42	Electronic card	107	Stirrup
7	O-ring	44	Washer	108	Washer
8	Circlips	46	Card support	110	Screw
9	Safety screw	101	Ground screw (inside)	111	Spring washer
10	O-ring	102	Grower washer	114	CHC screw
11	Shaft	103	Stirrup	220	Opto-electronic sensor
12	Cover	104	Washer	221	Support
14	Serial plate	105	Ground screw (outside)	222	Screw
23	Primary gear	106	Grower washer		

# 8. Risk Assessment

## 8.1 Identification of risks

The table below is the potential source of risk according to the EN 61010-1

Risk Identification and reference to EN 61010-1	Equipment related	Description	Risk reduction
6 - Protection against electric shock	Yes	Internal connections, wiring, cable entry, clearance and creepage	<b>Requested</b>
7- Protection against mechanical HAZARDS	Yes	Cover by The Supply of Machinery (Safety) Regulations 2008. Device only supply to industrial market. Safety manual instructions	Done by design
8 - Resistance to mechanical stresses	Yes	Enclosure stresses for some of the tests	Done by design
9 to 9.5 - Protection against the spread of fire	No	Enclosure is made to support internal explosion/fire without any transmission.	Done by design
9.6 - Protection against the spread of fire (Overcurrent protection)	Yes	Need external switches, circuit-breakers	<b>Requested</b>
10 - Equipment temperature limits and resistance to heat	Yes	Current drawing components generate heat increase. Surface temperature to be controlled	Done by design
11 - Protection against hazards from fluids and solid foreign objects	Yes	Cleaning task and water/dust protection	Done by design
12 - Protection against radiation, including laser sources, and against sonic and ultrasonic pressure	No	Not Concerned	Not concerned
13 - Protection against liberated gases and substances, explosion and implosion	No	Not Concerned	Not concerned
14 - Components and sub-assemblies	Yes	Connector, detectors	Done by design
15 - Protection by interlocks	Yes	Cover is locked by a screw to avoid opening without a tools.	Done by design
16 - HAZARDS resulting from application	Yes	Cover by The Supply of Machinery (Safety) Regulations 2008 . Device only supply to industrial market. Safety manual instructions	Done by design



## 8.2. Risk analysis

496 series is fully controlled during the manufacturing process to cover all relevant requirements of the EN 61010-1 standards. However, 496 series need some additional operations to be functional on final user site. This means to make the electrical connections inside the 496 enclosure, to ensure voltage and current from power supply are compatible with the 496 detectors and to secure the power line with protection devices. These actions/checks are out of Baker Hughes scope and responsibilities. Nevertheless, Baker Hughes risk analysis below must be read, understood and applied by qualified and competent professionals.

Please carefully read the risk analysis below to understand the potential injury that could happen if some requirements are not 100% applied.

Hazard identification	Type of issue	reasonably foreseeable misuse	Reinforcement factors	Gravity	Probability	Category	Description of measure to mitigate the risk to an acceptable level
Electrical shock on the enclosure	Loss of clearance/creepage due to wires in contact with metallic parts	Female end connections of voltage source not insulated.	Insufficient torque apply on the screws. External factors as temperature change, vibrations. Personal not qualified for electrical installation.	GRAVE	POSSIBLE	2	ALL requirements listed §6.4 of the safety instruction manual must be applied. Installed, put into service and maintained by qualified and competent professionals who have undergone suitable training for electrical installation
		No external clamping module to provide additional mechanical strength for cable strain relief	Risk of wires and/or detector broken in case of cable grabbing	GRAVE	POSSIBLE	2	ALL requirements listed §6.1 of the safety instruction manual must be applied. Installed, put into service and maintained by qualified and competent professionals who have undergone suitable training for electrical installation
	Loss of clearance/creepage due to excessive humidity or liquid or dust inside the enclosure.	Wrong cable gland or cable selection (cable diameter incompatible with the cable gland)	Weatherproof protection altered. Personal not qualified for electrical installation.	GRAVE	POSSIBLE	2	ALL requirements listed §6.1 and §6.2 of the safety instruction manual must be applied. Installed, put into service and maintained by qualified and competent professionals who have undergone suitable training for electrical installation
	None overcurrent protection	External protection against overcurrent type switch or circuit-breaker not installed or wrong protective device	Unpredictable human actions Personal not qualified for any maintenance, operations on the device	GRAVE	POSSIBLE	2	ALL requirements listed §6.3 of the safety instruction manual must be applied. Installed, put into service and maintained by qualified and competent professionals who have undergone suitable training for electrical installation

# 9. Maintenance



- Before carrying out any work on the device, power off the instrument for safe opening of the cover.
- Before power up or after doing any work on the device always check:
  - O-ring (10) is free of any damage
  - the insulator is well in place and covers the wiring connections for types 496-155, 496-255
  - the cover (12) is fully screwed and security screw (9) is well locked
  - Inside housing and cover are free of any humidity or dust

- Once a year, check the gaskets and in the event of damage, replace the defective parts with manufacturer's genuine parts only.
- For use in dusty atmosphere, regularly proceed to a cleaning of the different sides of the enclosure to avoid the deposits of dusts, the maximum thickness must be <5 mm.

- Check that no part of the 496 is damaged. In the event of damage, replace the defective parts with manufacturer's genuine part.
- Pay particular attention to the following:
  - Check device, mechanical link and general aspect.
  - Check the cable gland and the electrical connections.
  - Check the condition of the O-ring (10) of cover (12) and O-ring (7) of the shaft (11).
  - Make sure that shaft (11) is not worn out or damaged.
  - If the shaft (11) must be removed, make sure the original circlips (8) is put back in place. Check that neither the housing nor the shaft are damaged.
  - Use only the grease types listed below:

Type	Manufacturer
SI 33	ORAPI
GRAPHENE 702	ORAPI
MOLYKOTE 111 COMPOUND	MOLYKOTE®
MULTILUB	MOLYKOTE®
GRIPCOTT NF	MOLYDAL





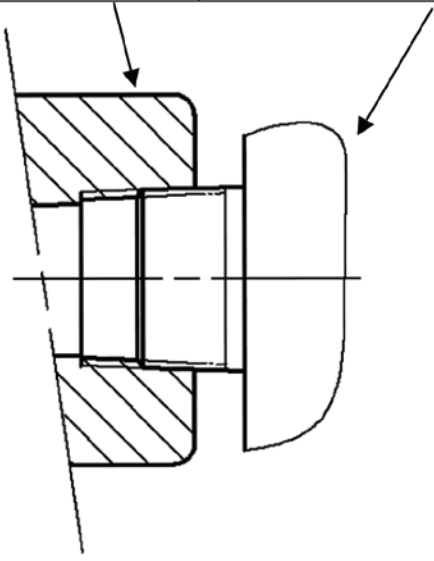
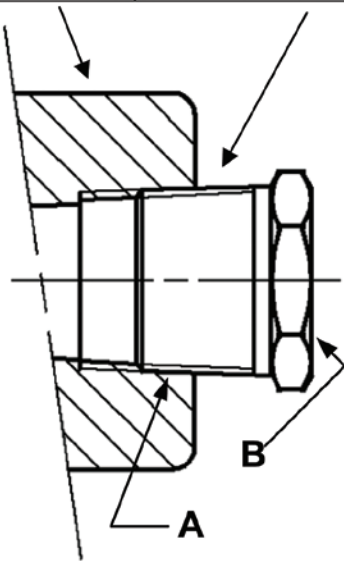

# Annex I - Cable and Adaptor - Reducer Mounting Rules

CABLE GLAND		ADAPTOR - REDUCER	
496 Housing	Cable gland with IP66/67	Housing	Adaptor-Reducer with IP66/67
			
<p><b>TYPE:</b> Male Taper (conical) threaded joint: <math>\frac{3}{4}</math>" NPT</p> <ul style="list-style-type: none"> <li>Conform to NPT requirements of ANSI/ASME B1.20.1</li> <li>A minimum of 5 threads provided on each part</li> </ul> <p><b>MOUNTING RULE:</b></p> <ul style="list-style-type: none"> <li>Thread cleaning with Loctite 7063 or equivalent product with similar efficiency.</li> <li>Cemented with Loctite 5400 (low strength thread sealant) or equivalent product with similar efficiency. This is mandatory to meet an IP67.</li> <li>Tightening torque (see Cable Gland instruction manual)</li> <li>Check threads engagement (see Cable Gland instruction manual)</li> </ul>		<p><b>A:</b></p> <p><b>TYPE:</b> Male Taper (conical) threaded joint: <math>\frac{3}{4}</math>" NPT</p> <ul style="list-style-type: none"> <li>Conform to NPT requirements of ANSI/ASME B1.20.1</li> <li>A minimum of 5 threads provided on each part</li> </ul> <p><b>MOUNTING RULE:</b></p> <ul style="list-style-type: none"> <li>Thread cleaning with Loctite 7063 or equivalent product with similar efficiency.</li> <li>Cemented with Loctite 2700 (high-strength threadlocker) or equivalent product with similar efficiency. This is mandatory to meet an IP67.</li> <li>Tightening torque (see Adaptor-Reducer instruction manual)</li> <li>Check threads engagement (see Adaptor-Reducer instruction manual)</li> </ul> <p><b>B:</b></p> <p><b>TYPE:</b> Female Taper (conical) thread joints: <math>\frac{1}{2}</math>" NPT or other NPT size</p> <ul style="list-style-type: none"> <li>Conform to NPT requirements of ANSI/ASME B.1.20.1</li> <li>A minimum of 5 threads provided on each part</li> </ul> <p><b>TYPE:</b> Female Cylindrical threaded joints: M20 x 1.5 or other sizes</p> <ul style="list-style-type: none"> <li>Conform to ISO 965-1 and ISO 965-3 requirements</li> <li>Minimum thread engaged: 5</li> <li>Depth of engagement: <math>\geq 8</math> mm</li> </ul> <p><b>MOUNTING RULE:</b></p> <ul style="list-style-type: none"> <li>Thread cleaning with Loctite 7063 or equivalent product with similar efficiency.</li> <li>Cemented with Loctite 5400 (low strength thread sealant) or equivalent product with similar efficiency. This is mandatory to meet an IP67.</li> <li>Tightening torque (see Cable Gland instruction manual)</li> <li>Check threads engagement (see Cable Gland instruction manual)</li> </ul>	

# Annex II - Y237 Adaptor - Mounting Rules

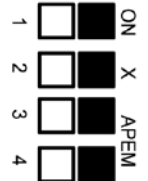
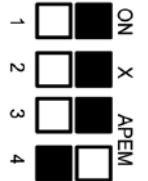
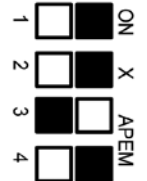
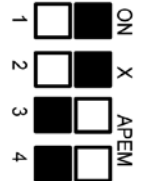
CABLE GLAND		PLUG	
Housing	Cable gland with IP66/67	Housing	Plug with IP66/67
<p><b>A:</b>  <b>TYPE:</b> Male Taper (conical) threaded joint: 3/4" NPT</p> <ul style="list-style-type: none"> <li>Conform to NPT requirements of ANSI/ASME B1.20.1</li> <li>A minimum of 5 threads provided on each part</li> </ul> <p><b>MOUNTING RULE:</b></p> <ul style="list-style-type: none"> <li>Thread cleaning with Loctite 7063 or equivalent product with similar efficiency.</li> <li>Cemented with Loctite 2700 (high-strength threadlocker) or equivalent product with similar efficiency. This is mandatory to meet an IP67.</li> <li>Tightening torque (see Cable Gland instruction manual)</li> <li>Check threads engagement (see Cable Gland instruction manual)</li> </ul> <p><b>B:</b>  <b>TYPE:</b> Female Taper (conical) thread joints: 1/2" NPT or 3/4" NPT</p> <ul style="list-style-type: none"> <li>Conform to NPT requirements of ANSI/ASME B.1.20.1</li> <li>A minimum of 5 threads provided on each part</li> </ul> <p><b>TYPE:</b> Female Cylindrical threaded joints: M20 x 1.5</p> <ul style="list-style-type: none"> <li>Conform to ISO 965-1 and ISO 965-3 requirements</li> <li>Minimum thread engaged: 5</li> <li>Depth of engagement: ≥ 8 mm</li> </ul> <p><b>MOUNTING RULE:</b></p> <ul style="list-style-type: none"> <li>Thread cleaning with Loctite 7063 or equivalent product with similar efficiency.</li> <li>Cemented with Loctite 5400 (low strength thread sealant) or equivalent product with similar efficiency. This is mandatory to meet an IP67.</li> <li>Tightening torque (see Cable Gland instruction manual)</li> <li>Check threads engagement (see Cable Gland instruction manual)</li> </ul>		<p><b>A:</b>  <b>TYPE:</b> Male Taper (conical) threaded joint: 3/4" NPT</p> <ul style="list-style-type: none"> <li>Conform to NPT requirements of ANSI/ASME B1.20.1</li> <li>A minimum of 5 threads provided on each part</li> </ul> <p><b>MOUNTING RULE:</b></p> <ul style="list-style-type: none"> <li>Thread cleaning with Loctite 7063 or equivalent product with similar efficiency.</li> <li>Cemented with Loctite 2700 (high-strength threadlocker) or equivalent product with similar efficiency. This is mandatory to meet an IP67.</li> <li>Tightening torque (see Cable Gland instruction manual)</li> <li>Check threads engagement (see Cable Gland instruction manual)</li> </ul> <p><b>B:</b>  <b>TYPE:</b> Female Taper (conical) thread joints: 1/2" NPT or 3/4" NPT</p> <ul style="list-style-type: none"> <li>Conform to NPT requirements of ANSI/ASME B.1.20.1</li> <li>A minimum of 5 threads provided on each part</li> </ul> <p><b>TYPE:</b> Female Cylindrical threaded joints: M20 x 1.5</p> <ul style="list-style-type: none"> <li>Conform to ISO 965-1 and ISO 965-3 requirements</li> <li>Minimum thread engaged: 5</li> <li>Depth of engagement: ≥ 8 mm</li> </ul> <p><b>MOUNTING RULE:</b></p> <ul style="list-style-type: none"> <li>Thread cleaning with Loctite 7063 or equivalent product with similar efficiency.</li> <li>Cemented with Loctite 2700 (high-strength threadlocker) or equivalent product with similar efficiency. This is mandatory to meet an IP67</li> <li>Tightening torque (see Cable Gland instruction manual)</li> <li>Check threads engagement (see Cable Gland instruction manual)</li> </ul>	

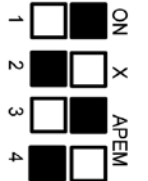
# Annex III - Switch Configuration

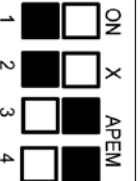
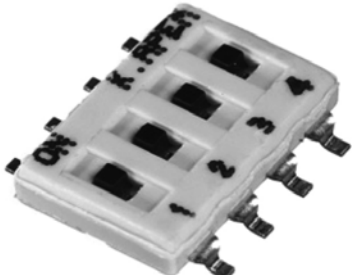
Switch Configuration According to the Rotation Angle of the Control Axle								
≤ 24° and < 30°	≤ 30° and < 36°	≤ 36° and < 42°	≤ 42° and < 48°	≤ 48° and < 54°	≤ 54° and < 62°	≤ 62° and < 70°	≤ 70° and < 80°	≤ 80° and ≤ 90°
								
Concerned Apparatus								
<ul style="list-style-type: none"> <li>• 87/88 strokes 1/2" to 0,8"</li> <li>• 37/38 strokes 1/2" to 3/4"</li> <li>• Sigma F stroke 3/4"</li> </ul>		<ul style="list-style-type: none"> <li>• Varimax</li> <li>• 67/68 stroke 5"</li> </ul>		<ul style="list-style-type: none"> <li>• Camflex</li> <li>• Varipak</li> <li>• 3100</li> <li>• 87/88 strokes 1" to 2,5"</li> <li>• 37/38 strokes 1" to 4"</li> <li>• Sigma F strokes 1,5" to 2"</li> <li>• 67/68 stroke 6"</li> </ul>		<ul style="list-style-type: none"> <li>• 67/68 stroke 8:</li> </ul>	<ul style="list-style-type: none"> <li>• Minitork</li> </ul>	<ul style="list-style-type: none"> <li>• Ball</li> </ul>
								

# Find the nearest local Channel Partner in your area:

[valves.bakerhughes.com/contact-us](https://valves.bakerhughes.com/contact-us)

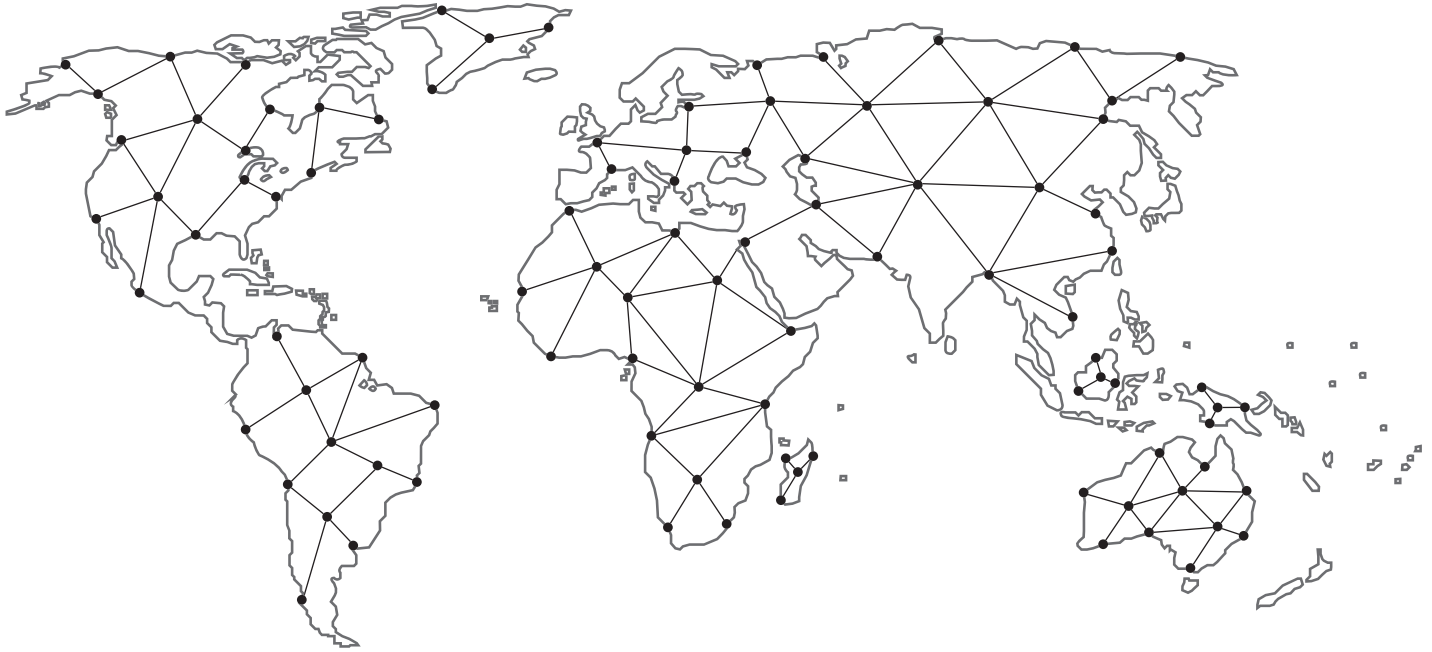

## Tech Field Support & Warranty:

Phone: +1-866-827-5378

[valvesupport@bakerhughes.com](mailto:valvesupport@bakerhughes.com)

[valves.bakerhughes.com](https://valves.bakerhughes.com)

Copyright 2024 Baker Hughes Company. All rights reserved. Baker Hughes provides this information on an "as is" basis for general information purposes. Baker Hughes does not make any representation as to the accuracy or completeness of the information and makes no warranties of any kind, specific, implied or oral, to the fullest extent permissible by law, including those of merchantability and fitness for a particular purpose or use. Baker Hughes hereby disclaims any and all liability for any direct, indirect, consequential or special damages, claims for lost profits, or third party claims arising from the use of the information, whether a claim is asserted in contract, tort, or otherwise. Baker Hughes reserves the right to make changes in specifications and features shown herein, or discontinue the product described at any time without notice or obligation. Contact your Baker Hughes representative for the most current information. The Baker Hughes logo, Masoneilan, Camflex, MiniTork, Varimax, and Varipak are trademarks of Baker Hughes Company. Other company names and product names used in this document are the registered trademarks or trademarks of their respective owners.

**Baker Hughes** 

[bakerhughes.com](https://bakerhughes.com)