

21000, 24701, and 164818 Proximity Probe Housing Assemblies

Datasheet

Cordant™

141600 Rev. AC

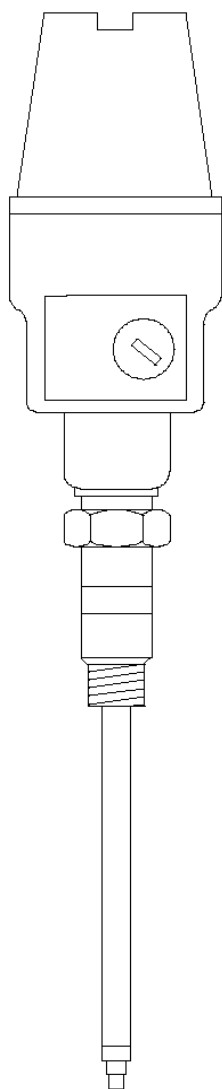

Description

To externally mount proximity probes, use one of these all-metal Proximity Probe Housing Assemblies:

- 21000 aluminum probe housing assembly
- 24701 stainless steel probe housing assembly

The 21000, 24701, and 164818 Proximity Probe Housing Assemblies consist of the following parts:

- A dome cover that screws into the body of the housing
- Threaded ports for conduit connections
- A probe sleeve of optional length
- O-rings
- A reverse mount proximity probe
- A thread seal
- Optional conduit fittings
- An optional standoff adapter



A newer 31000/32000 proximity probe housing assembly is available with more flexible mounting options, better environmental resistance, and other improved features. We recommend this proximity probe housing assembly for installations where an explosion proof housing is not required. See 31000 and 32000 Proximity Probe Housings product datasheet (document 141610).

The 21000, 24701, and 164818 Proximity Probe Housing Assemblies are available with Canadian Standards Association (CSA) approvals. They are rated explosion proof for hazardous areas.



You can order hazardous area approved proximity probes with 21000 aluminum and 24701 stainless steel housings for intrinsically safe applications. Both housings are certified as CSA Type 4 enclosures and are fully compliant with the American Petroleum Institute's (API) 670 Standard for externally mounted proximity probe housings.

The 164818 Compact Proximity Probe Housing is also available for applications with space restrictions. Ceramic capped probes are available with the 164818 housing.

Sleeve length is determined by the location in which the probe and housing are installed. The probe lead must be longer than the sleeve. Sleeve lengths longer than 304 mm (12 inches) require additional sleeve support to reduce the vibration associated with unsupported long sleeve lengths.

Bently Nevada offers a probe support and oil seal (part number 37948-01) for long sleeves that must go through an inner bearing housing. We also make custom sleeve supports.

Related Documents

For probe information, refer to the following manuals:

- *3300 XL 8mm & 3300 5mm Proximity Transducer System User Guide* (document 141078)
- *3300 XL NSv Proximity Transducer System User Guide* (document 147357)
- *3300 XL 11mm Proximity Transducer System Installation User Guide* (document 146255)
- *Radiation Resistant Probe and Proximator System* (document TW8029407)

Specifications

Environmental

Temperature Range

3300 XL 8mm Probe

Operating and storage	-51°C to +177°C (-60°F to +351°F)
-----------------------	-----------------------------------

3300 XL 11mm Probe

Operating and storage	-51°C to +177°C (-60°F to +351°F)
-----------------------	-----------------------------------

3300 NSv Probe

Operating	-34°C to +177°C (-30°F to +351°F)
-----------	-----------------------------------

Storage	-51°C to +177°C (-60°F to +351°F)
---------	-----------------------------------

Monitor Module	1 full-height front slot
I/O Modules	1 full-height rear slot

CAUTION

EQUIPMENT DAMAGE

Exposing 3300 XL or 3300 NSv probes to temperatures below -34°C (-30°F) may cause premature failure of their pressure seals.

Mechanical

Material

21000	Aluminum body with 304 stainless steel sleeve
24701	303 stainless steel body, with 304 stainless steel sleeve

Mass (Weight)

21000	1.1 kg (2.4 lb) typical, without fittings
24701	1.8 kg (4.1 lb) typical, without fittings

Compliance and Certifications

RoHS

European Community Directive:

RoHS Directive 2011/65/EU

Hazardous Area Approvals



For the detailed listing of country and product-specific approvals, refer to the [Approvals Quick Reference Guide \(108M1756\)](#).

For additional technical documentation, please log in to bntechsupport.com and access the Bently Nevada Media Library.

21000 and 24701

CA21000 and CA24701 housings are certified by CSA for explosion-proof applications in the following areas:

North America	Class I Divisions 1 and 2 Groups C and D Class II Divisions 1 and 2 Groups E, F, and G Circuit is non-incendive when connected per drawing 140979 Class III Enclosure Type 4 T5 @ Ta = -50°C to +40°C T4 @ Ta = -50°C to +80°C
---------------	--

CA housings can only be ordered for North American End Users. For all other end user countries, housings 21000 and 24701 must be ordered.

Ordering Information



For the detailed listing of country and product-specific approvals, refer to the [Approvals Quick Reference Guide \(108M1756\)](#).

For additional technical documentation, please log in to bntechsupport.com and access the Bently Nevada Media Library.

Proximity Probe Housing Assemblies

21000-AA-BB-CC-DDD-EE-FF

A: Probe with Connector

00	Probe not required
14	420 nuclear
16	3300 XL 8mm probe
26	3300 XL NSv probe
27	3300 XL NSv probe, selectable hazardous area approvals
28	3300 XL 8mm probe, selectable hazardous area approvals
29	3300 XL 11mm probe
30	3300 XL 11mm probe, selectable hazardous area approvals
31	3300 XL NSv probe with connector protector
32	3300 XL NSv probe with connector protector, selectable hazardous area approvals
33	3300 XL 8mm probe with connector protector
34	3300 XL 8mm probe with connector protector, selectable hazardous area approvals

35	3300 XL 11mm probe with connector protector
36	3300 XL 11mm probe with connector protector, selectable hazardous area approvals
37	3300 XL 8mm probe, ETR, selectable hazardous area approvals (available for 21000 only)

B: Probe Cable Length

00	Probe cable not required
05	0.5 m (20 in)
10	1.0 m (39 in)
12	12.0 in
18	18.0 in
24	24.0 in
30	30.0 in
36	36.0 in

C: Standoff Adapter (Option C Dimension)

15	Minimum length 1.5 in (38 mm)
75	Maximum length 7.5 in (191 mm)

Recommendation

Order in increments of 0.5 in (13 mm)

Examples

1.5 in (38 mm) = **15**
 No standoff adapter = **00**

D: Probe Penetration (Option D Dimension)

10	Minimum length 1.0 in (25.4 mm)
Other	

Recommendation

Order in increments of 0.1 in (3 mm)

Examples

3.7 in (94 mm) = **037**

22.4 in (569 mm) = **224**



Probe P/N and S/N may be displayed on a flag label for some combinations of the C plus D options where only a small section of the probe cable is visible.



For probe penetration lengths between 1.0 and 2.0 inches, it may be necessary to counter bore the machine case to reduce probe side view or rear view effects.



If you select a probe penetration length (C plus D) greater than 300 mm (12 in), you must add sleeve support near the probe to prevent resonance from occurring. Adjustment range of probe penetration option D is 13 mm (± 0.5 in). For the maximum value of C plus D, see [Figure 1: 21000/CA21000 Proximity Probe Housing Assembly on page 16](#).

E: Fittings

00	Without fittings
01	One 3/4-14 NPT explosion-proof fitting One 3/4-14 NPT plug
02	Two 3/4-14 NPT explosion-proof fittings
03	One 3/4-14 NPT plug One 3/4-14 to 1/2-14 NPT reducer One cable seal grip with grommets for the following cable sizes: <ul style="list-style-type: none"> • 1/8 to 3/16 inches • 1/4 to 5/16 inches • 5/16 to 3/8 inches
04	One 3/4-14 NPT plug only



Although explosion-proof fittings are available for all housings, only CA versions of the housing are rated as explosion-proof by CSA when ordered with the **E:00**, **E:01**, **E:02**, or **E:04** options.

F: Mounting Thread

01	As cast without threads
02	3/4-14 NPT Must be ordered if Standoff Adapter Length option is not 00 .
04	1/2-14 BSP

24701-AA-BB-CC-DDD-EE-FF

A: Probe with Connector

00	Probe not required
14	420 nuclear
16	3300 XL 8mm probe
26	3300 XL NSv probe
27	3300 XL NSv probe, with approval option
28	3300 XL 8mm, with approval option
29	3300 XL 11mm
30	3300 XL 11mm, with approval option
31	3300 XL NSv with connector protector
32	3300 XL NSv with connector protector and approval option
33	3300 XL 8mm with connector protector
34	3300 XL 8mm with connector protector and approval option

35	3300 XL 11mm with connector protector
36	3300 XL 11mm with connector protector and approval option
37	3300 XL 8mm ETR, with approval option

B: Probe Cable Length

00	Probe cable not required
05	20 in (0.5 m)
10	39 in (1.0 m)
12	12.0 ft (3.6 m)
18	18.0 ft (3.6 m)
24	24.0 ft (7.3 m)
30	24.0 ft (7.3 m)
36	36.0 ft (10.9 m)

C: Standoff Adapter (Option C Dimension)

15	Minimum length 1.5 in (38 mm)
75	Maximum length 7.5 in (191 mm)
	Examples 1.5 in (38 mm) = 15 No standoff adapter = 00
	Recommendation Order in increments of 0.5 in (13 mm)

D: Probe Penetration (Option D Dimension)

010	Minimum length 1.0 in (25.4 mm)
Other	See Figure 2: 24701/CA24701 Proximity Probe Housing Assembly on page 17.

	Example 3.7 in (94 mm) = 037 22.4 in (569 mm) = 224
	Recommendation Order in increments of 0.1 in (3 mm)

 Probe P/N and S/N may be displayed on a flag label for some combinations of the C plus D options where only a small section of the probe cable is visible.

 For probe penetration lengths between 1.0 and 2.0 inches, it may be necessary to counter bore the machine case to reduce probe side view or rear view effects.

 If you select a probe penetration length (C plus D) greater than 300 mm (12 in), you must add sleeve support near the probe to prevent resonance from occurring. Adjustment range of probe penetration option D is 13 mm (± 0.5 in). For the maximum value of C plus D, see [Figure 2: 24701/CA24701 Proximity Probe Housing Assembly on page 17.](#)

E: Fittings

00	Without fittings
01	One 3/4-14 NPT explosion-proof fitting One 3/4-14 NPT plug
02	Two 3/4-14 NPT explosion-proof fittings

03	One 3/4-14 NPT plug One 3/4-14 to 1/2-14 NPT reducer One cable seal grip with grommets for the following cable sizes: <ul style="list-style-type: none"> • 1/8 to 3/16 inches • 1/4 to 5/16 inches • 5/16 to 3/8 inches
04	One 3/4-14 NPT plug only

 Although explosion-proof fittings are available for all housings, only CA versions of the housing are rated as explosion-proof by CSA when ordered with the **E:00**, **E:01**, **E:02**, or **E:04** options.

F: Mounting Thread

01	As cast without threads
02	3/4-14 NPT (see note [1] below) <div style="border: 1px solid black; padding: 5px; margin-top: 10px;">  Must be ordered if Standoff Adapter Length Option is not 00. </div>
03	1-11 1/2 NPT (see note [1] below)
04	1/2-14 BSP
05	7/8-14 UNF-2A

 (1) For CA21000 housing, option F must be 02. Options 02 and 03 for mounting threads have more threads than standard NPT threads. They have been machined to have approximately 5 - 7 full threads to increase mounting strength and stiffness.

Explosion-Proof Housing Assemblies

 For CA21000 housing, option F must be 02. Options 02 and 03 for mounting threads have more threads than standard NPT threads. They have been machined to have approximately 5 - 7 full threads to increase mounting strength and stiffness.

CA21000-AA-BB-CC-DDD-EE-F02

 Options **A:00** and **B:00** are linked. If you choose **A:00**, you must also select **B:00**.

A: Probe with Connector

00	Probe not required
01	190 series, CSA, BNPS connector
02	190 series, CSA, API connector
27	3300 XL NSv, multiple approval
28	3300 XL 8mm, multiple approval
30	3300 XL 11mm, multiple approval
32	3300 XL NSv with connector protector, multiple approval
34	3300 XL 8mm with connector protector, multiple approval
36	3300 XL 11mm with connector protector, multiple approval

B: Probe Cable Length

05	0.5 meter (20 inches)
10	1.0 meter (39 inches)

C: Standoff Adapter (Option C Dimension)

15	Minimum length 1.5 in (38 mm)
-----------	-------------------------------

75	Maximum length 7.5 in (191 mm)
	Example 1.5 in (38 mm) = 15 No Standoff adapter = 00
	Recommendation Order in increments of 0.5 in (13 mm)

D: Probe Penetration (Option D Dimension)

010	Minimum length 1.0 in (25.4 mm)
Other	See Figure 1: 21000/CA21000 Proximity Probe Housing Assembly on page 16.
	Example 3.7 in (94 mm) = 037 22.4 in (569 mm) = 224
	Recommendation Order in increments of 0.1 in (3 mm)

 Probe P/N and S/N may be displayed on a flag label for some combinations of the C plus D options where only a small section of the probe cable is visible.

 For probe penetration lengths between 1.0 and 2.0 inches, it may be necessary to counter bore the machine case to reduce probe side view or rear view effects.

 If you select a probe penetration length (C plus D) greater than 300 mm (12 in), you must add sleeve support near the probe to prevent resonance from occurring. Adjustment range of probe penetration option D is 13 mm (± 0.5 in). For the maximum value of C plus D, see [Figure 1: 21000/CA21000 Proximity Probe Housing Assembly on page 16.](#)

E: Fittings

00	Without fittings
01	One 3/4-14 NPT explosion-proof fitting One 3/4-14 NPT plug
02	Two 3/4-14 NPT explosion-proof fittings
03	One 3/4-14 NPT plug One 3/4-14 to 1/2-14 NPT reducer One cable seal grip with grommets for the following cable sizes: <ul style="list-style-type: none">• 1/8 to 3/16 inches• 1/4 to 5/16 inches• 5/16 to 3/8 inches
04	One 3/4-14 NPT plug only

 Although explosion-proof fittings are available for all housings, only CA versions of the housing are rated as explosion-proof by CSA when ordered with the E:00, E:01, E:02, or E:04 options.

When ordering a proximator and an extension cable with the housing, choose a probe with matching approval options.

 You can only order probes for CA21000 or CA24701 with multiple approvals. To order CA versions with no probe, select the A:00 option.

CA24701-AA-BB-CC-DDD-EE-FF

A: Probe with Connector

00	Probe not required
01	190 series, CSA, BNPS connector
02	190 series, CSA, API connector
27	3300 XL NSv , multiple approval
28	3300 XL 8mm, multiple approval
30	3300 XL 11mm, multiple approval
32	3300 XL NSv with connector protector, multiple approval
34	3300 XL 8mm with connector protector, multiple approval
36	3300 XL 11mm with connector protector, multiple approval

B: Probe Cable Length

00	Probe cable not required
05	20 in (0.5 m)
10	39 in (1.0 m)
12	12.0 ft (3.6 m)

18	18.0 ft (3.6 m)
24	24.0 ft (7.3 m)
30	24.0 ft (7.3 m)
36	36.0 ft (10.9 m)

C: Standoff Adapter (Option C Dimension)

15	Minimum length 1.5 in (38 mm)
75	Maximum length 7.5 in (191 mm)
	Examples 1.5 in (38 mm) = 15 No standoff adapter = 00
	Recommendation Order in increments of 0.5 in (13 mm)

D: Probe Penetration (Option D Dimension)

010	Minimum length 1.0 in (25.4 mm)
Other	See Figure 2: 24701/CA24701 Proximity Probe Housing Assembly on page 17.
	Example 3.7 in (94 mm) = 037 22.4 in (569 mm) = 224
	Recommendation Order in increments of 0.1 in (3 mm)

 Probe P/N and S/N may be displayed on a flag label for some combinations of the C plus D options where only a small section of the probe cable is visible.

 For probe penetration lengths between 1.0 and 2.0 inches, it may be necessary to counter bore the machine case to reduce probe side view or rear view effects.

 If you select a probe penetration length (C plus D) greater than 300 mm (12 in), you must add sleeve support near the probe to prevent resonance from occurring. Adjustment range of probe penetration option D is 13 mm (± 0.5 in). For the maximum value of C plus D, see [Figure 2: 24701/CA24701 Proximity Probe Housing Assembly on page 17](#).

E: Fittings

00	Without fittings
01	One 3/4-14 NPT explosion-proof fitting One 3/4-14 NPT plug
02	Two 3/4-14 NPT explosion-proof fittings
03	One 3/4-14 NPT plug One 3/4-14 to 1/2-14 NPT reducer One cable seal grip with grommets for the following cable sizes: <ul style="list-style-type: none"> • 1/8 to 3/16 inches • 1/4 to 5/16 inches • 5/16 to 3/8 inches
04	One 3/4-14 NPT plug only

 Although explosion-proof fittings are available for all housings, only CA versions of the housing are rated as explosion-proof by CSA when ordered with the E:00, E:01, E:02, or E:04 options.

When ordering a proximator and an extension cable with the housing, choose a probe with matching approval options.

 You can only order probes for CA21000 or CA24701 with multiple approvals. To order CA versions with no probe, select the A:00 option.

F: Mounting Thread

01	As cast without threads
02	3/4-14 NPT (see note [1] below).  Must be ordered if Standoff Adapter Length Option is not 00.
03	1-11 1/2 NPT (see note [1] below)
04	1/2-14 BSP
05	7/8-14 UNF-2A

 (1) For CA21000 housing, option F must be 02. Options 02 and 03 for mounting threads have more threads than standard NPT threads. They have been machined to have approximately 5 - 7 full threads to increase mounting strength and stiffness.

164818 Compact Proximity Probe Housing

164818-AA-BB-CCC-DD-EE-FF-GG

A: Probe with Connector	
00	No probe
01	3300 XL NSv probe
02	3300 XL 8mm probe
03	3300 XL 11mm probe
04	3300 8mm ceramic-capped probe
05	3300 XL NSv probe with multiple approvals
06	3300 XL 8mm probe with multiple approvals
07	3300 XL 11mm probe with multiple approvals
08	3300 8mm Ceramic Capped Probe with multiple approvals
12	3300 XL 8mm probe with connector protector
16	3300 XL 8mm probe with connector protector, multiple approvals

See [Figure 3: 164818 Compact Proximity Probe Housing on page 18](#).

B: Cap Height	
20	2.0 inches
40	4.0 inches
60	6.0 inches

C: Sleeve Length	
016	Minimum length 1.6 in (40.6 mm)
292	Maximum length 29.2 in (741.7 mm)
	Examples
	3.0 in (76.2mm) = 030
	22.4 in (569 mm) = 224

Recommendation	
	Order in increments of 0.1 in (3 mm)

D: Mounting Thread	
01	3/4-14 NPT
02	G 3/4 (3/4-14 BSPP)
03	M24 x 1.5

E: O-ring Option	
01	Viton
02	Neoprene
03	Ethylene propylene

F: Rear Thread Type	
01	1/2-14 NPT
02	M16 x 1.5
03	M20 x 1.5

G: Probe Cable Length	
05	0.5 meter (20 in)
10	1.0 meter (39 in)

Accessories

Part Number	Description
37948-01	Probe Support / Oil Seal Recommended for sleeves longer than 305 mm (12 in)

Individual Probe Sleeve for 21000/24701 Proximity Probe Housings 44382-AAA

A: Measured Probe Sleeve Length	
	Recommendation
	Order in increments of 0.1 in (3 mm)

The individual probe sleeve length does **not** include the distance from the end of the sleeve to the probe tip or the gap from the probe tip to the target material. If only the part number of the original housing is known, and the sleeve cannot be measured, use the following table to determine the sleeve length:

AAA	Description
Standoff adapter option from original housing (21000, CA21000, 24701, or CA24701 option C) plus Probe penetration option from original housing (21000, CA21000, 24701, or CA24701 option D) and 045	All housing AAA options except NSv and 11mm probes (options other than A:06, A:12, A:26, A:27, A:29, A:30, A:31, A:32, A:35, or A:36) Example Original part number 21000-16-10-15-035-03-02 AAA option for replacement sleeve (015 + 035 + 045) = 095
Standoff Adapter Option from original housing (21000, CA21000, 24701, or CA24701 option C) plus Probe penetration option from original housing (21000, CA21000, 24701, or CA24701 option D) and 046	Housing AAA options for 3300 NSv probe options (A:26, A:27, A:31, or A:32) Example Original part number 24701-31-10-15-090-03-02 AAA option for replacement sleeve (015 + 090 + 046) = 151
Standoff Adapter Option from original housing (21000, CA21000, 24701, or CA24701 option C) plus Probe penetration option from original housing (21000, CA21000, 24701, or CA24701 option D) and 037	Housing AAA options for 3300 XL 11mm probe options (A:29, A:30, A:35, or A:36) Example Original part number CA24701-36-10-40-053-02-02 AAA option for replacement sleeve (040 + 053 + 037) = 130

AAA	Description
Standoff Adapter Option from original housing (21000, CA21000, 24701, or CA24701 option C) plus Probe penetration option from original housing (21000, CA21000, 24701, or CA24701 option D) and 039	Housing AAA options for 7200 Series 11mm probe options (A:06 or A:12) Example Original part number CA24701-12-10-30-113-01-02 AAA option for replacement sleeve (030 + 113 + 039) = 182

Minimum Probe Sleeve Length

For all probes except NSv and 11mm probes	5.5 in (140 mm) = 055
3300 XL NSv probe	5.5 in (142 mm) = 056
3300 XL 11mm probe	4.7 in (119 mm) = 047

Maximum Probe Sleeve Length

All 0.5 meter probes except NSv and 11mm probes	18.0 in (457 mm) = 180
3300 XL NSv 0.5 meter probe	18.1 in (460 mm) = 181
7200-series 0.5 meter 11mm probe	15.4 in (391 mm) = 154
All 1.0 meter probes except NSv and 11mm probes	33.7 in (856 mm) = 337
3300 XL NSv 1.0 meter probe	33.8 in (859 mm) = 338
3300 XL 1.0 meter 11mm probe	32.9 in (836 mm) = 329
7200 Series 1.0 meter 11mm probe	33.1 in (841 mm) = 331

Individual Standoff Adapter 21003-AAA

A: Individual Standoff Adapter

015	Minimum length 1.5 in (38 mm)
075	Maximum length 7.5 in (191 mm)
Recommendation	Order in increments of 0.5 in (13 mm) 4.5 in (114 mm) = 045

Example 1	For desired probe penetration lengths of less than 25 mm (1.0 in), order a separate Individual Standoff Adapter.
	The effective probe penetration length will then be reduced by the length of the Individual Standoff Adapter, plus an additional 13 mm (0.5 in) due to the NPT thread engagement.

Example 2

To create a probe penetration length 13 mm (0.5 in), order a 21000 housing with DDD (probe penetration) option of 030 [76 mm (3 in)] and a separate individual standoff adapter that is 51 mm (2.0 in) in length (part number 21003-020).

The standoff adapter covers 38 mm (2.0 in) of the probe sleeve **plus** an additional 13 mm (0.5 in).

Therefore, the effective probe penetration length drops to 13 mm (0.5 in).



If you use effective penetration lengths of less than 1.0 inches, signal effects are likely due to probe side view or rear view of metal components.

Spare 3300 XL 8mm Reverse Mount Probe, 3/8-24 UNF threads

330105-02-12-CC-DD-EE

A: Total Length

05	0.5 meter (1.6 feet)
10	1.0 meter (3.3 feet)
15	1.5 meter (4.9 feet)
20	2.0 meter (6.6 feet)
50	5.0 meter (16.4 feet)
90	9.0 meter (29.5 feet)

B: Connector

00	Connector not installed
02	Miniature ClickLoc coaxial connector

Agency Approval	
00	Not required
05	Multiple approvals

Spare 3300 NSv Reverse Mount Probe, 3/8-24 UNF threads

330906-02-12-CC-DD-EE

C: Total Length

05	0.5 meter (1.6 feet)
10	1.0 meter (3.3 feet)
50	5.0 meter (16.4 feet)
70	7.0 meter (23.0 feet)

D: Connector

00	Connector not installed
02	Miniature ClickLoc coaxial connector

E: Agency Approval

00	Not required
05	Multiple approvals

00	Without connector
02	With miniature male coaxial connector

E: Agency Approval

00	Not required
05	Multiple approvals

Spare 3300 XL 11mm Reverse Mount Probe, 3/8-24 UNF threads

330705-02-18-CC-DD-EE

C: Total Length

10	0.5 meter (1.6 feet)
50	5.0 meter (16.4 feet)
90	9.0 meter (29.5 feet)

D: Connector

Graphs and Figures

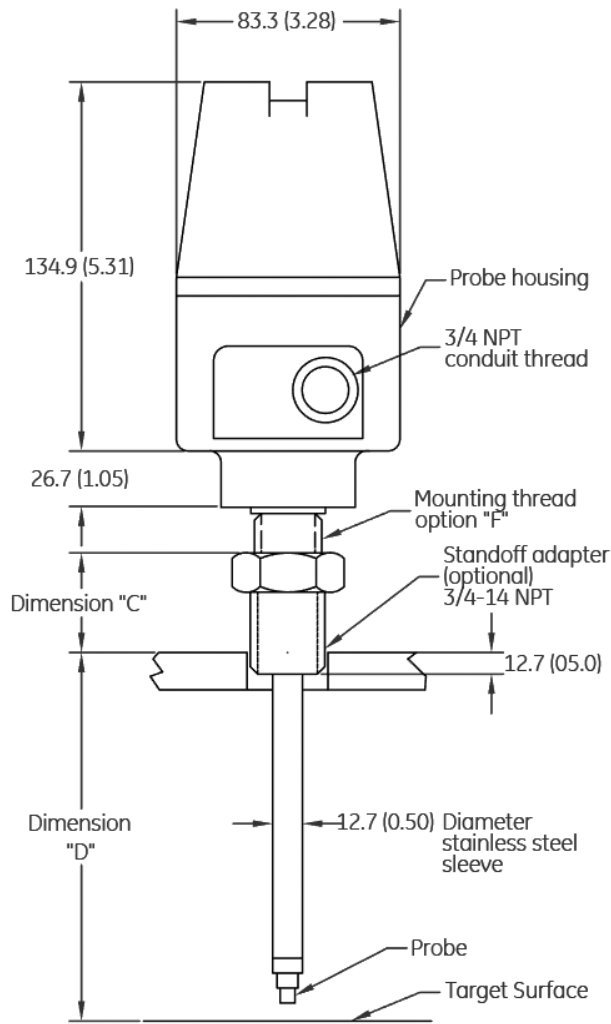

Probe Cable Length	Maximum (C) + (D) with visible probe (P/N and S/N)	Maximum (C) + (D) Dimension
12 in	Not visible	5.0 in (12.7 cm)
18 in	4.0 in (10.1 cm)	10.5 in (26.6 cm)
24 in	9.7 in (24.6 cm)	16.1 in (40.9 cm)
30 in	15.4 in (39.1 cm)	21.7 in (51.1 cm)
36 in	21.1 in (53.6 cm)	27.3 in (69.3 cm)
0.5 m	Not visible	13.5 in (34.3 cm)
1.0 m	17.0 in (43.18 cm)	32.9 in (83.5 cm)

Figure 1: 21000/CA21000 Proximity Probe Housing Assembly

Dimensions are in millimeters (inches).

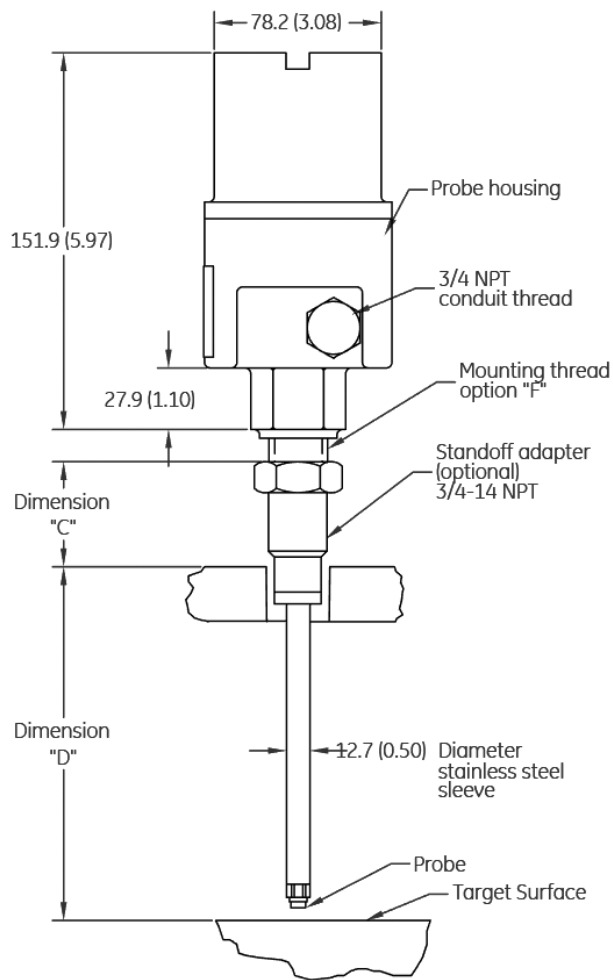

24701/CA24701 Dimensions

Probe Cable Length	Maximum (C) + (D) with visible probe (P/N and S/N)	Maximum (C) + (D) Dimension
12 in	Not visible	5.0 in (12.7 mm)
18 in	4.0 in (10.1 cm)	10.5 in (26.6 mm)
24 in	9.7 in (24.6 cm)	16.1 in (40.9 mm)
30 in	15.4 in (39.1 mm)	21.7 in (51.1 mm)
36 in	21.1 in (53.6 mm)	27.3 in (69.3 mm)
0.5 m	Not visible	13.5 in (34.3 mm)
1.0 m	17.0 in (43.18 mm)	29.2 in (74.2 mm)

Figure 2: 24701/CA24701 Proximity Probe Housing Assembly

Dimensions are in millimeters (inches).

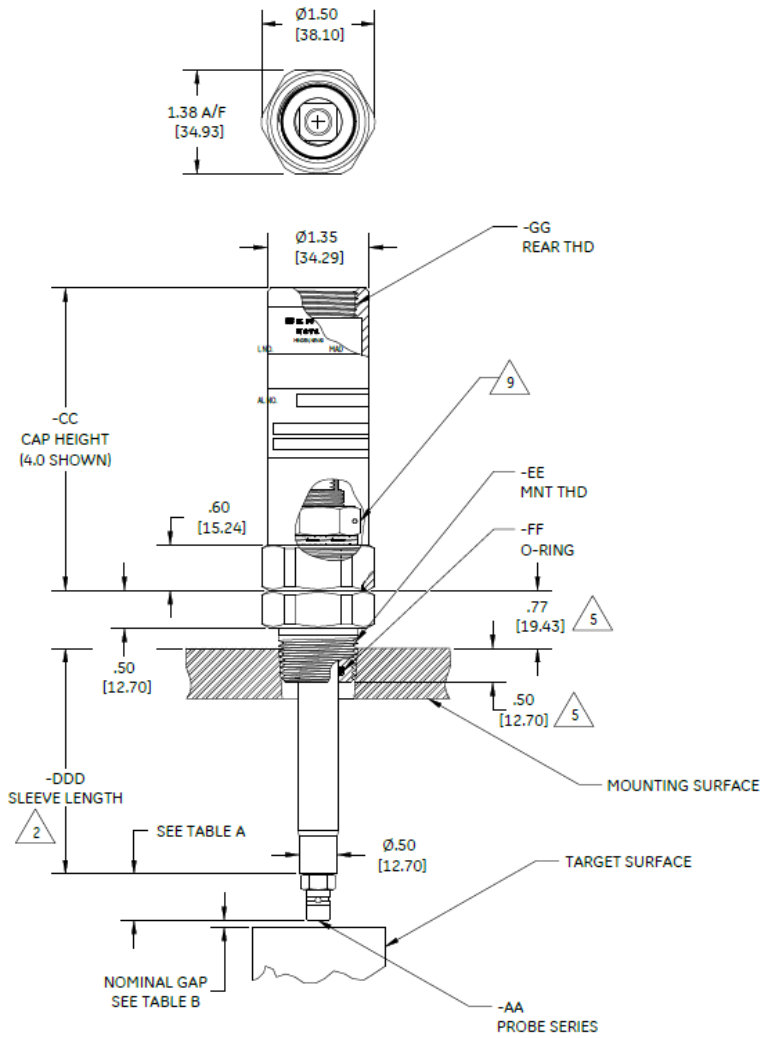

Table A - Probe Dimensions

Probe	Dimension
7200 8mm	0.60 [15.2]
XL NSv	0.52 [13.1]
XL 8mm	0.60 [15.2]
XL 11mm	1.31 [33.3]
Ceramic	0.90 [22.9]

Table B - Nominal Gap (Reference Only)

Probe	Dimension
7200 8mm	0.05 [1.3]
XL NSv	0.04 [1.0]
XL 8mm	0.05 [1.3]
XL 11mm	0.10 [2.5]
Ceramic	0.04 [1.0]

Figure 3: 164818 Compact Proximity Probe Housing

Dimensions are in inches [millimeters].

Tables

Table 1: For Figure 1, Dimensions in mm (inches).

Catalog Number	Dimension			
	A	B	C and D	E
21000	83.3 (3.28)	161.6 (6.36)	See Ordering Option C & D	26.7 (1.05)
24701	78.2 (3.08)	151.9 (5.97)	See Ordering Option C & D	27.9 (1.10)

Table 2: Maximum Length of C and D Dimension for Proximity Probes

Probe Cable Length	Maximum C and D Dimension
0.5 meter (3300 Series)	343 mm (13.5 in)
1.0 meter	742 mm (29.2 in)

Table 3: Maximum C and Dimension with Standard P/N and S/N Label (non-flag label)

Probe Cable Length	Maximum C and D Dimension
0.5 meter	Not visible
1.0 meter	432 mm (17 m)

Copyright 2026 Baker Hughes Company. All rights reserved.

Bently Nevada, a Baker Hughes Company
1631 Bently Parkway South, Minden, Nevada USA 89423
<https://bntechsupport.com>